

HITACHI

SET FREE Σ

VARIABLE REFRIGERANT FLOW SYSTEM

AIR SOURCE HEAT PUMP TYPE

AIR SOURCE HEAT RECOVERY TYPE



Cooling & Heating

Welcome



Air. It's a wonderful thing.

Invisible, silent and life-giving, air makes our entire world possible. It surrounds us, continuously energising, cooling and warming. It can be unpredictable and sometimes challenging, but when air is in harmony with us, everything seems that much easier.

**This is our vision.
To create the air that makes life better.**

Living Harmony

At Hitachi Cooling & Heating we like to think of this as creating harmony with your interior environment. When we achieve that wonderful balance, productivity, learning, happiness and health can thrive.

We call this 'Living Harmony' and it's at the center of everything we do.

The future together

Living Harmony puts people first. By balancing the human needs of our customers with an uncompromising approach to innovation and quality, we can continue to create the technologies for a more comfortable and balanced world.

Your world. We live in it together.

The beauty of balance

No matter what the weather is like outside, when you're indoors, you want to have complete control over your environment. At work or play, awake or asleep, you're free to create your own atmosphere; balancing energy with calm, sound with silence and light with shade. It's the same for cooling and heating.

When the air around you is in balance, you can enjoy life indoors that much more.

INDEX

03 VRF OUTDOOR UNITS

05 AIR SOURCE HEAT PUMP TYPE

29 AIR SOURCE HEAT RECOVERY TYPE

51 VRF INDOOR UNITS & VENTILATION

53 LINE UP OVERVIEW

57 DUCTED

63 CONCEALED & EXPOSED

68 CEILING CASSETTE

73 VENTILATIONS

75 CONTROLLERS

77 LINE UP OVERVIEW

79 INDIVIDUAL CONTROLLERS

85 CENTRALISED CONTROLLERS

93 H-LINK

95 OTHERS

97 OUR HERITAGE



VRF OUTDOOR UNITS

05	AIR SOURCE HEAT PUMP TYPE
06	HIGH EFFICIENCY
07	DESIGN FLEXIBILITY
08	BETTER PERFORMANCE
09	ADAPTABILITY
11	SPECIFICATIONS
11	HIGH EFFICIENCY MODEL: FSNP SERIES
19	SPACE SAVING MODEL: FSNS SERIES
27	OPTIONAL PARTS FOR HEAT PUMP TYPE

29	AIR SOURCE HEAT RECOVERY TYPE
30	HIGH EFFICIENCY
31	WHAT IS HEAT RECOVERY?
33	DESIGN FLEXIBILITY
37	ADAPTABILITY
39	SPECIFICATIONS
39	HIGH EFFICIENCY MODEL: FSXNP SERIES
44	SPACE SAVING MODEL: FSXNS SERIES
49	OPTIONAL PARTS FOR HEAT RECOVERY TYPE

AIR SOURCE HEAT PUMP TYPE

LINE UP

High efficiency model: FSNP series
Space saving model: FSNS series

Single Module
up to 18HP class (FSNP)
up to 24HP class (FSNS)



Two Modules Combination
up to 36HP class (FSNP)
up to 48HP class (FSNS)



Three Modules Combination
up to 54HP class (FSNP)
up to 72HP class (FSNS)



Whole range
up to 72HP class (FSNP)
up to 96HP class (FSNS)



SUMMARY TABLE

Item	Unit	High efficiency model: FSNP series	Space saving model: FSNS series
Capacity	HP class	5-72	8-96
Nominal Cooling Capacity	kW	14.0 - 201.0	22.4-268.0
Nominal Heating Capacity	kW	16.0 - 225.0	25.0-305.0
Maximum Connectable Indoor Unit Quantity		64	64
Combination Capacity Ratio Between ODU and IDU *	%	50-150	50-130
Total Piping Length	m	1,000	1,000
Maximum Piping Length Between ODU and IDU	m	165	165
Maximum Equivalent Piping Length Between ODU and IDU	m	190	190
Maximum Piping Length Between 1st Branch and IDU	m	90	90
Maximum Height Difference Between ODU and IDU ** (when ODU is higher than IDU)	m	110	110
Maximum Height Difference Between ODU and IDU ** (when IDU is higher than ODU)	m	110	110
Maximum Height Difference Between IDU and IDU	m	30	30
Cooling Operation Range ***	°C DB	-5.0 to 52.0	-5.0 to 48.0
Heating Operation Range ***	°C WB	-20.0 to 15.0	-20.0 to 15.0

* 50-150% (5-54HP class)/50-130% (56-72HP class) (FSNP series)

** Please consult Temperzone or your dealer if the height different is over 50 metres. The maximum piping length for 56 to 72HP class (FSNP) is 90 metres.

*** For more details, please consult Temperzone or your dealer, or, refer to technical manuals.

Note: In case the outdoor unit is higher than the indoor units, the standard level difference between outdoor and indoor units is 50m. 110m height difference is possible with a dip switch setting on the outdoor unit (contact Temperzone for details). If the indoor units are higher than the outdoor units, then the standard level difference is 40m. 110m level difference is possible by special order on the factory

HIGH EFFICIENCY

EFFICIENCY RATIO

High efficiency model: FSNP series

Cooling EER

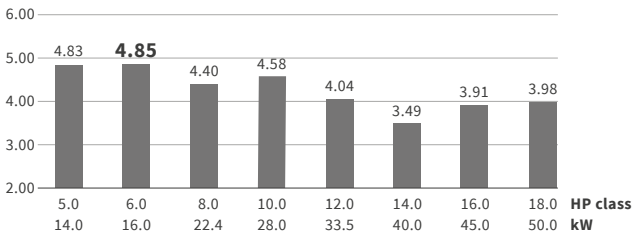

Heating COP

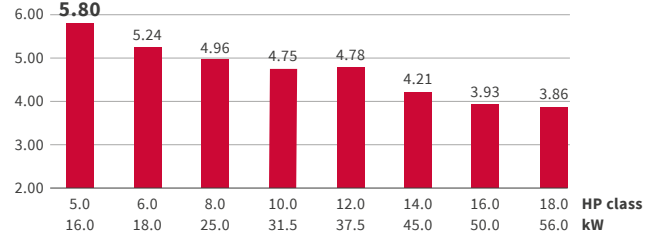

NOTES:

1. The graphs above show the EER/COP of single units for Oceania.
2. The above values indicate the EER/COP per outdoor unit when it is combined with specified indoor units.
3. The specification of EER/COP of each country is different according to the regulation. Please contact your sales person for more information.

Space saving model: FSNS series

Cooling EER

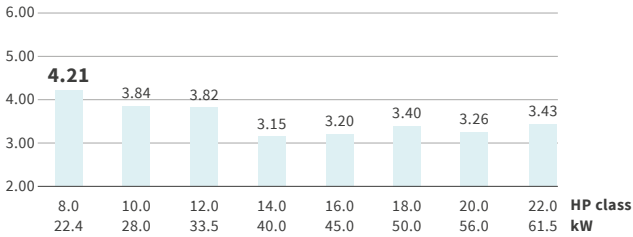

Heating COP

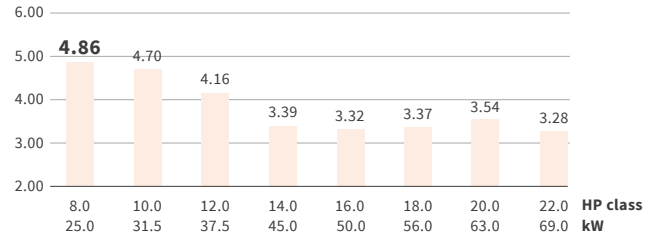

NOTES:

1. The graphs above show the EER/COP of single units for Oceania.
2. The above values indicate the EER/COP per outdoor unit when it is combined with specified indoor units.
3. The specification of EER/COP of each country is different according to the regulation. Please contact your sales person for more information.



DESIGN FLEXIBILITY

EASY TRANSPORTATION

Smaller

Can be transported in an elevator
FSNS: 18HP class(50.0kW)

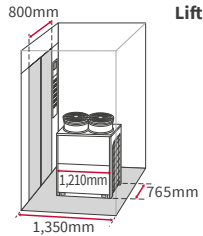

Lighter

New package design with crane attachment points

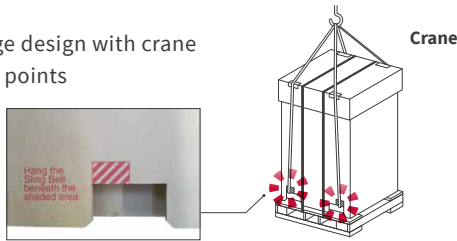

AMBIENT OPERATING TEMPERATURES

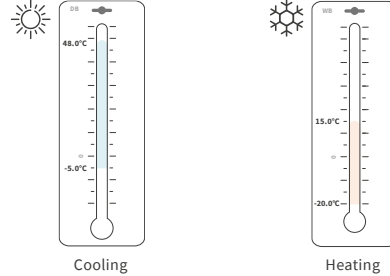

NOTES:

- Cooling operation at maximum 48.0°C DB should be available only if the outdoor air inlet temperature increase temporarily according to the installation condition.
- The cooling capacity is reduced at high ambient temperature. Consider selecting a larger capacity outdoor unit than compatible building heat load.
- The appropriate amount (100%) of refrigerant must be charged. Excessive charging of refrigerant is not permitted.
- Avoid installing the units where affected by direct sunlight reflection and short circuit. There may be the possibility to activate protection control and alarm system if install the units to inappropriate place. Also the life time of the products and parts must be shortened.
- Periodic maintenance (1/certain month) must be applied to the heat exchanger fin to avoid adhesion of dirt and clogging of sand to the outdoor unit heat exchanger.
- Refer to the technical catalogue for the detail.
- Operation temperature range in simultaneous heating & cooling varies depending on whether mainly heating or mainly cooling. Refer to technical catalogue for more detail.

PIPING CONNECTION WORKABILITY

Improvement of restrictions on piping construction

- Suitable for a high-rise building or complex facilities.
- Leads to cost/time saving for designers, with more efficient design.

	Total sum		1,000m
Maximum piping length	Maximum length from ODU stope valve or Piping connection kit to Terminal IDU	Actual	165m
	Between Piping Connection Kit and Each ODU	Equivalent	190m
	Between 1st branch Multi Kit and the farthest IDU		10m
	Between each Multi Kit and each IDU		90m
	Between each Multi Kit and each IDU		40m
Maximum level difference	Between ODUs		0.1m
	Between ODU and IDU	ODU above IDU	Standard: 50m Optional: 110m
		IDU above ODU	Standard: 40m Optional: 110m
	Between IDUs		30m

Notes:

In case the outdoor unit is higher than the indoor units, the standard level difference between outdoor and indoor units is 50m. 110m height difference is possible with a dip switch setting on the outdoor unit. (Contact Temperzone for details)
If the indoor units are higher than the outdoor units, then the standard level difference is 40m. 110m level difference is possible by special order on the factory

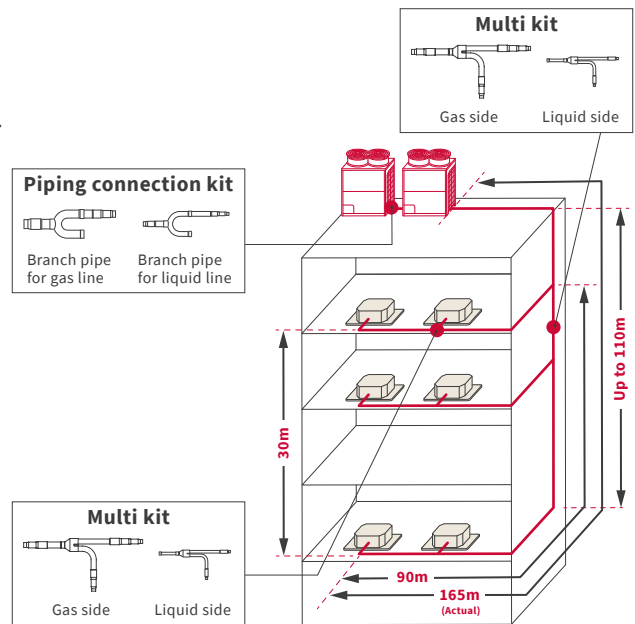

WIDER EXTERNAL STATIC PRESSURE

Designed to be located internally and can operate under 4 ESP settings, up to 80Pa, with multiple options for improved energy savings

New Model 4 Options available

0Pa **30Pa** **60Pa** **80Pa**

Shorter required piping lengths provide greater design flexibility and may also reduce installation costs

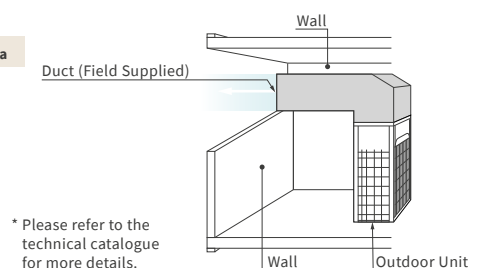

BETTER PERFORMANCE

SMOOTH DRIVE: SUPERIOR CYCLE CONTROL

“Smooth Drive” is designed to solve the issue that “COP is much lower in low load operation” which has been raised by specialists for long time, by optimising both compressor and fan operation in the smoothest way.

Exclusive to Hitachi VRF technology, this newly developed refrigerant cycle control technology, Smooth Drive, helps you achieve new standards in performance and efficiency with our new outdoor units.

How does it benefit you?



Efficiency

Power consumption is reduced by -39% in tested conditions at 33% load.



Comfort

More constant indoor temperature achieved by better responsiveness thanks to direct compressor frequency control.



Reliability

Less burden on compressor thanks to suppressing continuous on/off at low load operation, leading to less liquid-back and less shock into the scroll compressor.

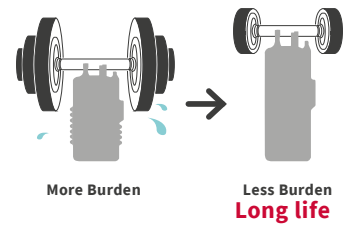
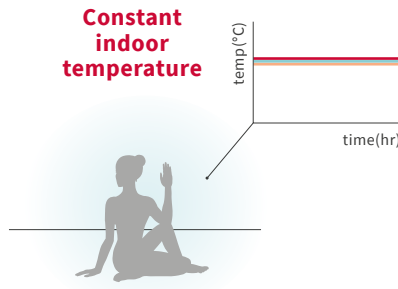
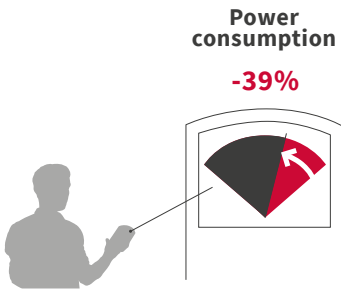

Actual example of the new compressor control

- Smooth Drive keeps the scroll compressor running at the optimal level by measuring the load level and calibrating the required amount of refrigerant
- As a result, power consumption is reduced by almost 39%

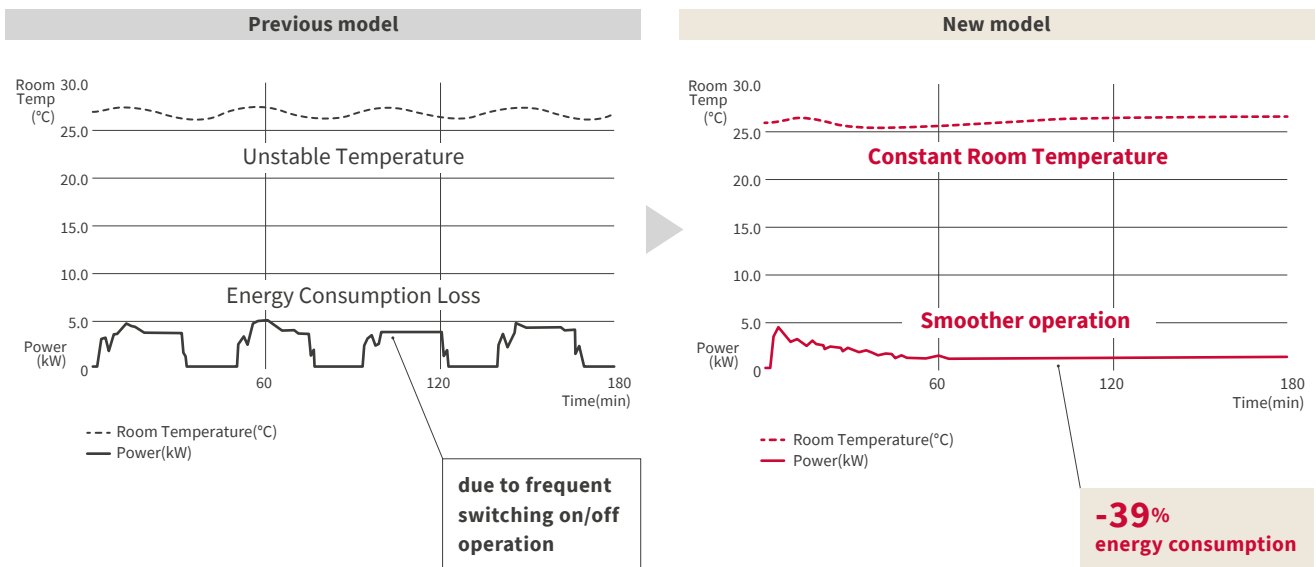

ADAPTABILITY

THE BEAUTY OF SILENCE

You can set up the night shift mode from Outdoor Unit PCB. The sound power level for a particular time zone can be set, based upon the usage environment.

Setting example (FSNS 14HP class)

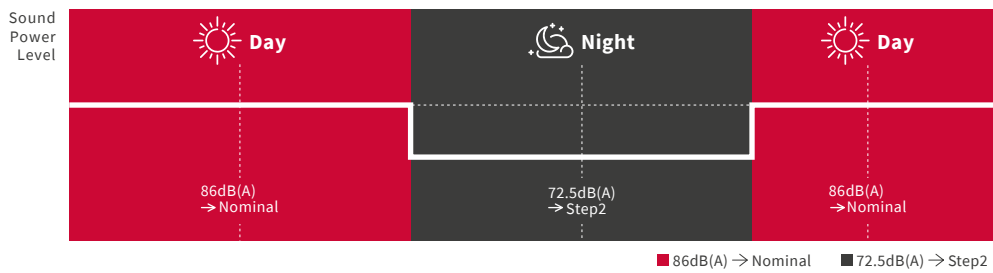

Noise Reduction mode	FSNS 14HP class(40.0kW)	FSNS 42HP class(118.0kW)
	Sound Power Level	Sound Power Level
Nominal	86	89
Step1	77.5	86
Step2	72.5	81
Step3	67.5	76

dB(A)

* The range of performance and operation is limited, since the rotation frequency of the compressor and ODU fan is reduced.

** Use of PC-ARF1 and limited indoor units only. Please consult Temperzone.

ROTATIONAL OPERATION

To improve unit endurance, standardised running time evenly distributes the load by rotating the order of compressor operation

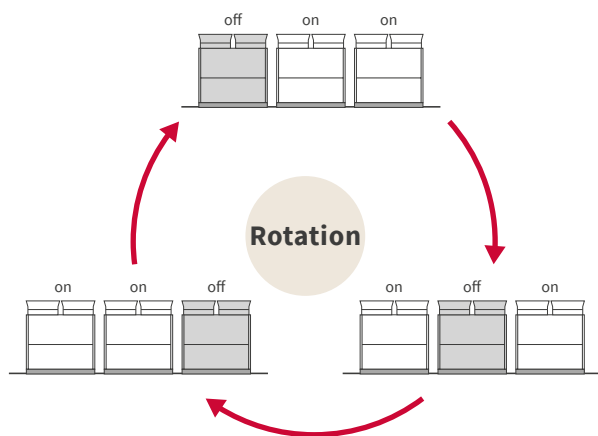

SYSTEM FAILURE PREVENTION

In case of a combination unit

- The Backup Operation Function prevents the system from coming to a complete stop when outdoor unit failure occurs
- If one outdoor unit should fail, the system can continue to operate using the remaining outdoor units
- An alarm is triggered and emergency operation can be activated via an individual remote control
- At least 2 outdoor units (as combined unit) are required for this function
- Emergency operation can be performed within 8 hours after unit stoppage

Combined ODU

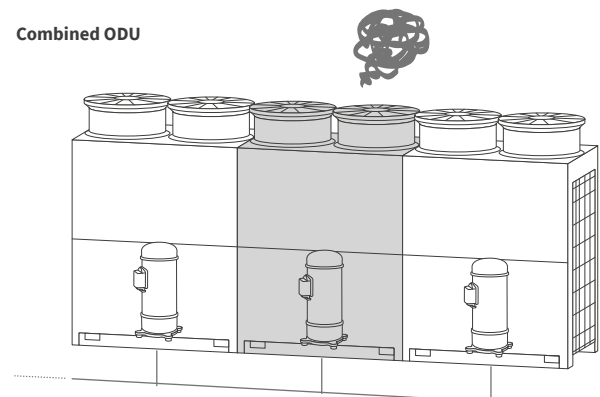

CORROSION RESISTANCE

Corrosion-resistance improved Heat Exchanger

3 Coating Layers

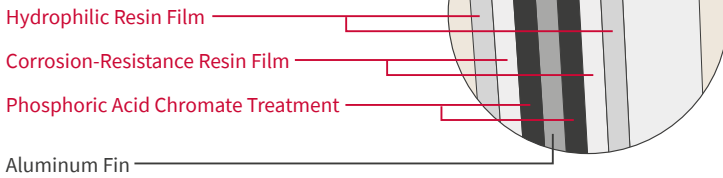

*Considered JRA9002: Criteria and Testing of Corrosion-proof for Refrigeration and Air Conditioning Equipment against Salty Air
 *Please consult Hitachi distributors for more details
 *Both "Anti-corrosive treatment" and "Heavy anti-corrosive treatment" are by custom order

(illustration purpose)
 Life-expectancy comparison
 In salty-air-location

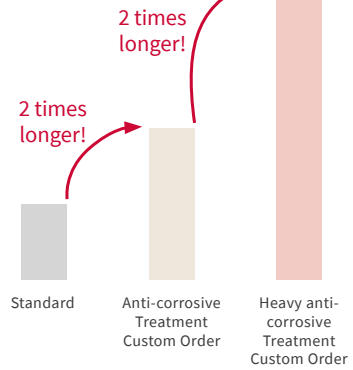

EASE OF MAINTENANCE

With a 7-segment display, revised upper and lower panels and convenient access to compressors and valves, SET FREE Σ outdoor units are easier to access, manage and maintain.

Total structure change

New Structure:
 In upper section, all PCB visible and easily accessible

Newly adopted window for 7-segment display:
 Adopting access door to the electrical box in the upper panel, which leads to easy access to 7-segment display, PSW & DSW and so on.



New Panel:
 The upper panel (on the side of an electric box) can be independently detached from the lower panel (on the compressor chamber side)

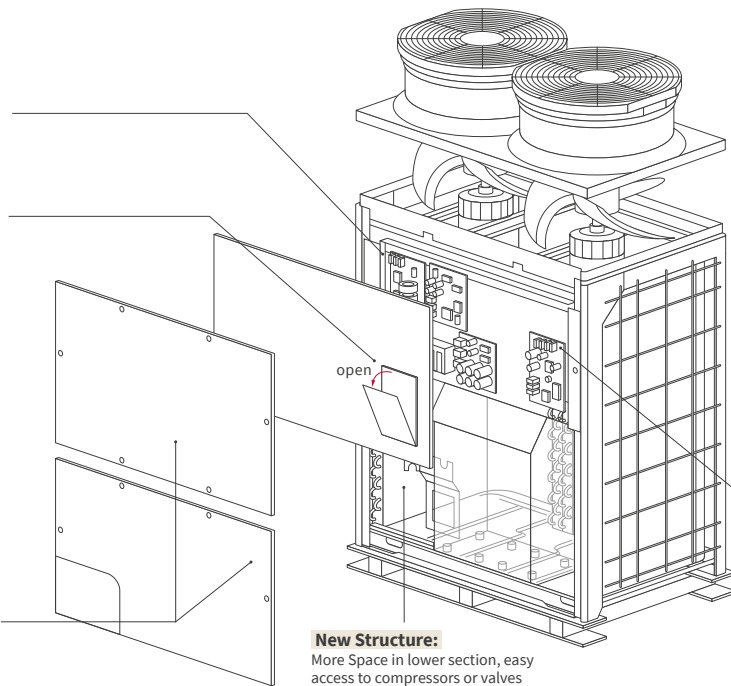

New Structure:
 More Space in lower section, easy access to compressors or valves

New DSW setting for Refrigerant evacuation:
 Enforced operation to open ODU EVO/EVB, IDU EVI, and Hi/Low pressure Bi-pass SVA

After DSW4-4 On

PSW4 () for 3 seconds

fully opening the expansion valves of outdoor unit (EVO, EVB) and the expansion valve of indoor unit (EVI), and opening the solenoid valve of outdoor unit (SVA)

REFRIGERANT 410A

Simplify "refrigerant recovery & evacuation work" and "air tight test" during servicing

Mechanical Contractor & Installer

SPECIFICATIONS

High efficiency model: FSNP series



HP class

Model

		5	6	8	10	12	14	
		RAS-5FSNP	RAS-6FSNP	RAS-8FSNP	RAS-10FSNP	RAS-12FSNP	RAS-14FSNP	
Power Supply		AC 3φ, [400V/50Hz] [380-415V/50Hz] [380V/60Hz] [220V/60Hz]						
Nominal Cooling Capacity		kW	14.0	16.0	22.4	28.0	33.5	40.0
Nominal Heating Capacity		kW	16.0	18.0	25.0	31.5	37.5	45.0
Cabinet	Colour	Natural Gray (1.0Y 8.5/0.5)						
	Munsell Code							
Outer Dimensions	H×W×D	mm	1,675×950×765	1,675×950×765	1,675×1,210×765	1,675×1,210×765	1,675×1,210×765	1,675×1,210×765
Sound Level	Sound Power Level	dB(A)	75	78	77	82	83	85
	Sound Pressure Level	dB(A)	54	56	55	59	60	62
Weight	Net Weight	400V/50Hz	190	190	255	259	260	270
		380-415V/50Hz						
	380V/60Hz	kg	185	185	250	254	255	265
	Gross Weight	400V/50Hz	kg	206	206	273	277	278
380-415V/50Hz								
380V/60Hz	kg	201	201	268	272	273	283	
Refrigerant	Type	R410A						
	Flow Control	Micro-Computer Control Expansion Valve						
	Charge (before Shipment)	kg	4.7	5.0	8.5	8.5	9.3	9.3
Compressor	Type	Hermetic (Scroll)						
	Model	AA50PHD	AA50PHD	AA50PHD	DB65PHD	DC80PHD	DC80PHD	
	Quantity	1	1	1	1	1	1	
	Motor Output (Pole)	kW	1.9(6)	2.1(6)	3.1(6)	3.8(6)	5.1(6)	6.4(6)
Refrigeration Oil	Type	FVC68D						
	Charge	L/Unit	6.0	6.0	6.0	6.0	6.0	6.9
Heat Exchanger		Multi-Pass Cross-Finned Tube						
Condenser Fan	Type	Propeller Fan						
	Quantity	1	1	2	2	2	2	
	Air Flow Rate	m³/min.	150	170	185	219	219	243
	Motor Output (Pole)	kW	0.20(8)	0.28(8)	0.18(8)×2	0.26(8)×2	0.26(8)×2	0.34(8)×2
Main Refrigerant Piping	Liquid Line	mm	φ9.52	φ9.52	φ9.52	φ9.52	φ12.7	φ12.7
Heat Recovery System (3 Pipes)	Gas Line	mm	φ15.88	φ19.05	φ19.05	φ22.2	φ25.4	φ25.4
Package	Dimensions H×W×D	mm	1,800×1,030×810	1,800×1,030×810	1,800×1,290×810	1,800×1,290×810	1,800×1,290×810	1,800×1,290+810
	Measurement	m³	1.5	1.5	1.9	1.9	1.9	1.9

Notes:

- The cooling and heating performances are the values when combined with our specified indoor units.
 Cooling Operation Conditions
 Indoor Air Inlet Temperature: 27.0°C DB
 19.0°C WB
 Outdoor Air Inlet Temperature: 35°C DB
 Piping Length: 7.5 metres
 Piping Lift: 0 metres
 Heating Operation Conditions
 Indoor Air Inlet Temperature: 20.0°C DB
 Outdoor Air Inlet Temperature: 7.0°C DB
 6.0°C WB
 Piping Length: 7.5 metres
 Piping Lift: 0 metre
- The sound pressure is based on the following conditions.
 The above data is based on the cooling mode. In case of heating mode, the sound pressure level increases by approximately 1~2 dB.
 The above data was measured in an anechoic chamber so that reflected sound should be taken into consideration in the field.
- The width of outer dimension, it is the value when each distance between the base outdoor units is specified to 20mm.



HP class

16 18 20 22 24

Model

RAS-16FSNP RAS-18FSNP RAS-20FSNP RAS-22FSNP RAS-24FSNP

Combination of Base Unit			-	-	RAS-10FSNP RAS-10FSNP	RAS-10FSNP RAS-12FSNP	RAS-12FSNP RAS-12FSNP	
Power Supply			AC 3φ, [400V/50Hz] [380-415V/50Hz] [380V/60H] [220V/60Hz]					
Nominal Cooling Capacity			kW	45.0	50.0	56.0	61.5	67.0
Nominal Heating Capacity			kW	50.0	56.0	63.0	69.0	77.5
Cabinet	Colour	Munsell Code	Natural Gray (1.0Y 8.5/0.5)					
	Outer Dimensions	H×W×D	mm	1,675×1,600×765	1,675×1,600×765	1,675×2,440×765	1,675×2,440×765	1,675×2,440×765
Sound Level	Sound Power Level		dB(A)	85	86	85	86	86
	Sound Pressure Level		dB(A)	65	65	62	62.5	63
Weight	Net Weight	400V/50Hz	kg	345	360	259+259	259+260	260+260
		380-415V/50Hz	kg					
	380V/60Hz	kg						
	220V/60Hz	kg	340	355	254+254	254+255	255+255	
Gross Weight	400V/50Hz	kg	365	380	277+277	277+278	278+278	
	380-415V/50Hz	kg						
380V/60Hz	kg							
220V/60Hz	kg	360	375	272+272	272+273	273+273		
Refrigerant	Type		R410A					
	Flow Control		Micro-Computer Control Expansion Valve					
	Charge (before Shipment)	kg	10.0	10.6	17.0	17.8	18.6	
Compressor	Type		Hermetic (Scroll)					
	Model		AA50PHD+AA50PHD DC80PHD+DC80PHD DB65PHD+DB65PHD DB65PHD+DC80PHD DC80PHD+DC80PHD					
	Quantity		2 2 2 2 2					
	Motor Output (Pole)	kW	3.7(6)×2	4.4(6)×2	3.8(6)×2	3.8(6)×1+5.1(6)×1	5.1(6)×2	
Refrigeration Oil	Type		FVC68D					
	Charge	L/Unit	7.9	7.9	12.0	12.0	12.0	
Heat Exchanger			Multi-Pass Cross-Finned Tube					
Condenser Fan	Type		Propeller Fan					
	Quantity		2 2 4 4 4					
	Air Flow Rate		m³/min.	326	362	219×2	219×2	219×2
	Motor Output (Pole)		kW	0.47(8)×2	0.62(8)×2	0.26(8)×+0.26(8)×2	0.26(8)×2+0.26(8)×2	0.26(8)×2+0.26(8)×2
Main Refrigerant Piping	Liquid Line	mm	φ12.7	φ15.88	φ15.88	φ15.88	φ15.88	
Heat Recovery System (3 Pipes)	Gas Line	mm	φ28.58	φ28.58	φ28.58	φ28.58	φ28.58	
Package	Dimensions	H×W×D	mm	1,800×1,680×810	1,800×1,680×810	-	-	-
	Measurement	m³		2.4	2.4	-	-	-

Notes:

- The cooling and heating performances are the values when combined with our specified indoor units.

Cooling Operation Conditions	Heating Operation Conditions
Indoor Air Inlet Temperature: 27.0°C DB	Indoor Air Inlet Temperature: 20.0°C DB
19.0°C WB	Outdoor Air Inlet Temperature: 7.0°C DB
Outdoor Air Inlet Temperature: 35°C DB	6.0°C WB
Piping Length: 7.5 metres (RAS-16~18FSNP), 10.0 metres (RAS-20~24FSNP)	Piping Length: 7.5 metres (RAS-16~18FSNP), 10.0 metres (RAS-20~24FSNP)
Piping Lift: 0 metres	Piping Lift: 0 metres
- The sound pressure is based on the following conditions.
 - The above data is based on the cooling mode. In case of heating mode, the sound pressure level increases by approximately 1~2 dB.
 - The above data was measured in an anechoic chamber so that reflected sound should be taken into consideration in the field.
- Except for the specified combination in the table (FSNP: 16~72HP class 45.0~201.0kW), there is no other combination of the base unit.
- The width of outer dimension, it is the value when each distance between the base outdoor units is specified to 20mm.

SET FREE Σ

SPECIFICATIONS

SPECIFICATIONS

High efficiency model: FSNP series



HP class

Model

			26	28	30	32	34	36		
			RAS-26FSNP	RAS-28FSNP	RAS-30FSNP	RAS-32FSNP	RAS-34FSNP	RAS-36FSNP		
Combination of Base Unit			RAS-10FSNP RAS-16FSNP	RAS-12FSNP RAS-16FSNP	RAS-12FSN PRAS-18FSNP	RAS-14FSNP RAS-18FSNP	RAS-16FSNP RAS-18FSNP	RAS-18FSNP RAS-18FSNP		
Power Supply			AC 3φ, [400V/50Hz] [380-415V/50Hz] [380V/60Hz] [220V/60Hz]							
Nominal Cooling Capacity			kW	73.0	77.5	85.0	90.0	95.0	100.0	
Nominal Heating Capacity			kW	82.5	90.0	95.0	100.0	106.0	112.0	
Cabinet	Colour	Munsell Code	Natural Gray (1.0Y 8.5/0.5)							
	Outer Dimensions	H×W×D	mm	1,675×2,830×765	1,675×2,830×765	1,675×2,830×765	1,675×2,830×765	1,675×3,220×765	1,675×3,220×765	
Sound Level	Sound Power Level		dB(A)	87	87	88	89	89	89	
	Sound Pressure Level		dB(A)	66	66	66	67	68	68	
Weight	Net Weight	400V/50Hz	kg	259+345	260+345	260+360	270+360	345+360	360+380	
		380-415V/50Hz	kg							
	380V/60Hz	kg								
	220V/60Hz	kg	254+340	255+340	255+355	265+355	340+355	355+355		
Gross Weight	400V/50Hz	kg	277+365	278+365	278+380	288+380	365+380	380+380		
	380-415V/50Hz	kg								
380V/60Hz	kg									
220V/60Hz	kg	272+360	273+360	273+375	283+375	360+375	375+375			
Refrigerant	Type		R410A							
	Flow Control		Micro-Computer Control Expansion Valve							
	Charge (before Shipment)	kg	18.5	19.3	19.9	19.9	20.6	21.2		
Compressor	Type		Hermetic (Scroll)							
	Model		DB65PHD+AA50PHD +AA50PHD		DC80PHD+AA50PHD +AA50PHD		DC80PHD+DC80PHD +DC80PHD		DC80PHD+DC80PHD +DC80PHD	
	Quantity		3		3		3		4	
	Motor Output (Pole)		kW		3.8(6)×1+3.7(6)×2	5.1(6)×1+3.7(6)×2	5.1(6)×1+4.4(6)×2	6.4(6)×1+4.4(6)×2	3.7(6)×2+4.4(6)×2	4.4(6)×2+4.4(6)×2
Refrigeration Oil	Type		FVC68D							
	Charge	L/Unit	13.9	13.9	13.9	14.8	15.8	15.8		
Heat Exchanger			Multi-Pass Cross-Finned Tube							
Condenser Fan	Type		Propeller Fan							
	Quantity		4		4		4		4	
	Air Flow Rate		m³/min.	219+326	219+326	219+362	243+362	326+362	362×2	
	Motor Output (Pole)		kW	0.26(8)×2 +0.47(8)×2	0.26(8)×2 +0.47(8)×2	0.26(8)×2 +0.62(8)×2	0.34(8)×2 +0.62(2)×2	0.47(2)×2 +0.62(2)×2	0.62(8)×2 +0.62(8)×2	
Main Refrigerant Piping	Liquid Line	mm	φ19.05	φ19.05	φ19.05	φ19.05	φ19.05	φ19.05		
Heat Recovery System (3 Pipes)	Gas Line	mm	φ31.75	φ31.75	φ31.75	φ31.75	φ31.75	φ38.1		

Notes:

- The cooling and heating performances are the values when combined with our specified indoor units.
Cooling Operation Conditions
Indoor Air Inlet Temperature: 27.0°C DB
19.0°C WB
Outdoor Air Inlet Temperature: 35°C DB
Piping Length: 10.0 metres (RAS-26~30FSNP),
12.5 metres (RAS-32~36FSNP)
Piping Lift: 0 metres
- The sound pressure is based on the following conditions.
The above data is based on the cooling mode. In case of heating mode, the sound pressure level increases by approximately 1-2 dB.
The above data was measured in an anechoic chamber so that reflected sound should be taken into consideration in the field.
- Except for the specified combination in the table (FSNP: 16~72HP class 45.0~201.0kW), there is no other combination of the base unit.
- The width of outer dimension, it is the value when each distance between the base outdoor units is specified to 20mm.



HP class

Model

			38	40	42	44	46	
			RAS-38FSNP	RAS-40FSNP	RAS-42FSNP	RAS-44FSNP	RAS-46FSNP	
Combination of Base Unit			RAS-12FSNP RAS-12FSNP RAS-14FSNP	RAS-12FSNP RAS-14FSNP RAS-14FSNP	RAS-14FSNP RAS-14FSNP RAS-14FSNP	RAS-12FSNP RAS-14FSNP RAS-18FSNP	RAS-14FSNP RAS-14FSNP RAS-18FSNP	
Power Supply			AC 3φ, [400V/50Hz] [380-415V/50Hz] [380V/60Hz] [220V/60Hz]					
Nominal Cooling Capacity	kW		106.0	112.0	118.0	122.0	128.0	
Nominal Heating Capacity	kW		118.0	125.0	132.0	140.0	145.0	
Cabinet	Colour	Munsell Code	Natural Gray (1.0Y 8.5/0.5)					
	Outer Dimensions	H×W×D	mm	1,675×3,670×765	1,675×3,670×765	1,675×3,670×765	1,675×4,060×765	1,675×4,060×765
Sound Level	Sound Power Level		dB(A)	89	89	90	90	90
	Sound Pressure Level		dB(A)	65.5	66	67	67.5	68
Weight	Net Weight	400V/50Hz 380-415V/50Hz 380V/60Hz	kg	260+260+270	260+270+270	270+270+270	260+270+360	270+270+360
		220V/60Hz	kg	255+255+265	255+265+265	265+265+265	255+265+355	265+265+355
	Gross Weight	400V/50Hz 380-415V/50Hz 380V/60Hz	kg	278+278+288	278+288+288	288+288+288	278+288+380	288+288+380
220V/60Hz		kg	273+273+283	273+283+283	283+283+283	273+283+375	283+283+375	
Refrigerant	Type	R410A						
	Flow Control	Micro-Computer Control Expansion Valve						
	Charge (before Shipment)	kg	27.9	27.9	27.9	29.2	30.5	
Compressor	Type	Hermetic (Scroll)						
	Model	DC80PHD+DC80PHD +DC80PHD		DC80PHD+DC80PHD +DC80PHD	DC80PHD+DC80PHD +DC80PHD	DC80PHD+DC80PHD +DC80PHD+DC80PHD	DC80PHD+DC80PHD +DC80PHD+DC80PHD	
	Quantity	3		3	3	4	4	
Refrigeration Oil	Motor Output (Pole)	kW	5.1(6)×2+6.4(6)×1	5.1(6)×1+6.4(6)×2	6.4(6)×3	5.1(6)×1+6.4(6)×1 +4.4(6)×2	6.4(6)×1+6.4(6)×1 +4.4(6)×2	
	Type	FVC68D						
Charge	L/Unit	18.9	19.8	20.7	20.8	21.7		
Heat Exchanger	Multi-Pass Cross-Finned Tube							
Condenser Fan	Type	Propeller Fan						
	Quantity	6		6	6	6	6	
	Air Flow Rate	m ³ /min.	219×2+243	219+243×2	243×3	219+243+362	243×2+362	
Motor Output (Pole)	kW	0.26(8)×2+0.26(8)×2 +0.34(8)×2	0.26(8)×2+0.34(8)×2 +0.34(8)×2	0.34(8)×2+0.34(8)×2 +0.34(8)×2	0.26(8)×2+0.34(8)×2 +0.62(8)×2	0.34(8)×2+0.34(8)×2 +0.62(8)×2		
Main Refrigerant Piping	Liquid Line	mm	φ19.05	φ19.05	φ19.05	φ19.05	φ19.05	
Heat Recovery System (3 Pipes)	Gas Line	mm	φ38.1	φ38.1	φ38.1	φ38.1	φ38.1	

- Notes:
- The cooling and heating performances are the values when combined with our specified indoor units.

Cooling Operation Conditions	Indoor Air Inlet Temperature: 27.0°C DB 19.0°C WB	Heating Operation Conditions	Indoor Air Inlet Temperature: 20.0°C DB Outdoor Air Inlet Temperature: 7.0°C DB 6.0°C WB
Outdoor Air Inlet Temperature: 35°C DB	Piping Length: 12.5 metres (RAS-38~44FSNP), 15.0 metres (RAS-46FSNP)	Piping Length: 12.5 metres (RAS-38~44FSNP), 15.0 metres (RAS-46FSNP)	Piping Lift: 0 metres
 - The sound pressure is based on the following conditions.

The above data is based on the cooling mode. In case of heating mode, the sound pressure level increases by approximately 1~2 dB.

The above data was measured in an anechoic chamber so that reflected sound should be taken into consideration in the field.
 - Except for the specified combination in the table (FSNP: 16~72HP class 45.0~201.0kW), there is no other combination of the base unit.
 - The width of outer dimension, it is the value when each distance between the base outdoor units is specified to 20mm.

SET FREE Σ

SPECIFICATIONS

SPECIFICATIONS

High efficiency model: FSNP series



HP class

48

50

52

54

Model

RAS-48FSNP

RAS-50FSNP

RAS-52FSNP

RAS-54FSNP

Combination of Base Unit			RAS-12FSNP RAS-18FSNP RAS-18FSNP	RAS-14FSNP RAS-18FSNP RAS-18FSNP	RAS-16FSNP RAS-18FSNP RAS-18FSNP	RAS-18FSNP RAS-18FSNP RAS-18FSNP	
Power Supply			AC 3φ, [400V/50Hz] [380-415V/50Hz] [380V/60Hz] [220V/60Hz]				
Nominal Cooling Capacity			kW	136.0	140.0	145.0	150.0
Nominal Heating Capacity			kW	150.0	155.0	160.0	165.0
Cabinet	Colour	Munsell Code	Natural Gray (1.0Y 8.5/0.5)				
	Outer Dimensions	H×W×D	mm	1,675×4,450×765	1,675×4,450×765	1,675×4,840×765	1,675×4,840×765
Sound Level	Sound Power Level		dB(A)	90	90	90	91
	Sound Pressure Level		dB(A)	68.5	69	70	70
Weight	Net Weight	400V/50Hz 380-415V/50Hz 380V/60Hz	kg	260+360+360	270+360+360	345+360+360	360+360+360
		220V/60Hz	kg	255+355+355	265+355+355	340+355+355	355+355+355
	Gross Weight	400V/50Hz 380-415V/50Hz 380V/60Hz	kg	278+380+380	288+380+380	365+380+380	380+380+380
		220V/60Hz	kg	273+375+375	283+375+375	360+375+375	375+375+375
Refrigerant	Type		R410A				
	Flow Control		Micro-Computer Control Expansion Valve				
	Charge (before Shipment)	kg	30.5	30.5	31.2	31.8	
Compressor	Type		Hermetic (Scroll)				
	Model		DC80PHD+DC80PHD +DC80PHD+DC80PHD +DC80PHD				
	Quantity		5				
	Motor Output (Pole)		kW	5.1(6)×1+4.4(6)×2+4.4(6)×2	6.4(6)×1+4.4(6)×2+4.4(6)×2	3.7(6)×2+4.4(6)×2+4.4(6)×2	4.4(6)×2+4.4(6)×2+4.4(6)×2
Refrigeration Oil	Type		FVC68D				
	Charge	L/Unit	21.8	22.7	23.7	23.7	
Heat Exchanger			Multi-Pass Cross-Finned Tube				
Condenser Fan	Type		Propeller Fan				
	Quantity		6				
	Air Flow Rate		m³/min.	219+362×2	243+362×2	326+362×2	362×3
	Motor Output (Pole)		kW	0.26(8)×2+0.62(8)×2 +0.62(8)×2	0.34(8)×2+0.62(8)×2 +0.62(8)×2	0.47(8)×2+0.62(8)×2 +0.62(8)×2	0.62(8)×2+0.62(8)×2 +0.62(8)×2
Main Refrigerant Piping	Liquid Line	mm	φ19.05	φ19.05	φ19.05	φ19.05	
Heat Recovery System (3 Pipes)	Gas Line	mm	φ38.1	φ38.1	φ38.1	φ38.1	

Notes:

1. The cooling and heating performances are the values when combined with our specified indoor units.

Cooling Operation Conditions

Indoor Air Inlet Temperature: 27.0°C DB
19.0°C WB

Outdoor Air Inlet Temperature: 35°C DB

Piping Length: 15.0 metres

Piping Lift: 0 metres

Heating Operation Conditions

Indoor Air Inlet Temperature: 20.0°C DB
Outdoor Air Inlet Temperature: 7.0°C DB

6.0°C WB

Piping Length: 15.0 metres

Piping Lift: 0 metres

2. The sound pressure is based on the following conditions.

The above data is based on the cooling mode. In case of heating mode, the sound pressure level increases by approximately 1~2 dB.

The above data was measured in an anechoic chamber so that reflected sound should be taken into consideration in the field.

3. Except for the specified combination in the table (FSNP: 16~72HP class 45.0~201.0kW), there is no other combination of the base unit.

4. The width of outer dimension, it is the value when each distance between the base outdoor units is specified to 20mm.



HP class

56

58

Model

RAS-56FSNP

RAS-58FSNP

Combination of Base Unit			RAS-12FSNP RAS-12FSNP RAS-14FSNP RAS-18FSNP	RAS-12FSNP RAS-14FSNP RAS-14FSNP RAS-18FSNP
Power Supply			AC 3φ, [400V/50Hz] [380-415V/50Hz] [380V/60Hz] [220V/60Hz]	
Nominal Cooling Capacity			kW 157.0	162.0
Nominal Heating Capacity			kW 176.0	181.0
Cabinet	Colour	Munsell Code	Natural Gray (1.0Y 8.5/0.5)	
	Outer Dimensions	H×W×D	mm 1,675×5,290×765	1,675×5,290×765
Sound Level	Sound Power Level		dB(A) 90	91
	Sound Pressure Level		dB(A) 68.5	68.5
Weight	Net Weight	400V/50Hz	kg 260+260+270+360	260+270+270+360
		380-415V/50Hz 380V/60Hz	kg 255+255+265+355	255+265+265+355
	Gross Weight	400V/50Hz	kg 278+278+288+380	278+288+288+380
		380-415V/50Hz 380V/60Hz	kg 273+273+283+375	273+283+283+375
Refrigerant	Type		R410A	
	Flow Control		Micro-Computer Control Expansion Valve	
	Charge (before Shipment)		kg 38.5	38.5
Compressor	Type		Hermetic (Scroll)	
	Model		DC80PHD+DC80PHD+DC80PHD+DC80PHD+DC80PHD	DC80PHD+DC80PHD+DC80PHD+DC80PHD+DC80PHD
	Quantity		5	5
	Motor Output (Pole)		kW 5.1(6)×2+6.4(6)+4.4(6)×2	5.1(6)+6.4(6)×2+4.4(6)×2
Refrigeration Oil	Type		FVC68D	
	Charge		L/Unit 26.8	27.7
Heat Exchanger			Multi-Pass Cross-Finned Tube	
Condenser Fan	Type		Propeller Fan	
	Quantity		8	8
	Air Flow Rate		m³/min. 219×2+243+362	219+243×2+362
	Motor Output (Pole)		kW (0.26(8)×2)×2+0.34(8)×2+0.62(8)×2	0.26(8)×2+(0.34(8)×2)×2+0.62(8)×2
Main Refrigerant Piping	Liquid Line		mm φ19.05	φ19.05
Heat Recovery System (3 Pipes)	Gas Line		mm φ44.45	φ44.45

Notes:

- The cooling and heating performances are the values when combined with our specified indoor units.

Cooling Operation Conditions	Heating Operation Conditions
Indoor Air Inlet Temperature: 27.0°C DB	Indoor Air Inlet Temperature: 20.0°C DB
19.0°C WB	Outdoor Air Inlet Temperature: 7.0°C DB
Outdoor Air Inlet Temperature: 35°C DB	6.0°C WB
Piping Length: 15.0 metres (RAS-56FSNP), 17.5 metres (RAS-58FSNP)	Piping Length: 15.0 metres (RAS-56FSNP), 17.5 metres (RAS-58FSNP)
Piping Lift: 0 metres	Piping Lift: 0 metres
- The sound pressure is based on the following conditions.
 The above data is based on the cooling mode. In case of heating mode, the sound pressure level increases by approximately 1~2 dB.
 The above data was measured in an anechoic chamber so that reflected sound should be taken into consideration in the field.
- Except for the specified combination in the table (FSNP: 16~72HP class 45.0~201.0kW), there is no other combination of the base unit.
- The width of outer dimension, it is the value when each distance between the base outdoor units is specified to 20mm.

SPECIFICATIONS

High efficiency model: FSNP series



60

RAS-60FSNP



62

RAS-62FSNP

HP class

Model

Combination of Base Unit			RAS-14FSNP RAS-14FSNP RAS-16FSNP RAS-16FSNP	RAS-14FSNP RAS-16FSNP RAS-16FSNP RAS-16FSNP
Power Supply			AC 3φ, [400V/50Hz] [380-415V/50Hz] [380V/60Hz] [220V/60Hz]	
Nominal Cooling Capacity			kW 167.0	174.0
Nominal Heating Capacity			kW 188.0	196.0
Cabinet	Colour	Munsell Code	Natural Gray (1.0Y 8.5/0.5)	
	Outer Dimensions	H×W×D	mm 1,675×5,680×765	1,675×6,070×765
Sound Level	Sound Power Level		dB(A) 91	91
	Sound Pressure Level		dB(A) 70	70.5
Weight	Net Weight	400V/50Hz	kg 270+270+345+345	270+345+345+345
		380-415V/50Hz		
	380V/60Hz	kg 265+265+340+340	265+340+340+340	
	220V/60Hz	kg 288+288+365+365	288+365+365+365	
Gross Weight	400V/50Hz	kg 283+283+360+360	283+360+360+360	
	380-415V/50Hz			
220V/60Hz	kg 283+283+360+360	283+360+360+360		
Refrigerant	Type		R410A	
	Flow Control		Micro-Computer Control Expansion Valve	
	Charge (before Shipment)		kg 38.6	39.3
Compressor	Type		Hermetic (Scroll)	
	Model		DC80PHD+DC80PHD+AA50PHD+AA50PHD +AA50PHD+AA50PHD	DC80PHD+AA50PHD+AA50PHD+AA50PHD +AA50PHD+AA50PHD
	Quantity		6	7
	Motor Output (Pole)		kW 6.4(6)×2+(3.7(6)×2)×2	6.4(6)+(3.7(6)×2)×3
Refrigeration Oil	Type		FVC68D	
	Charge		L/Unit 29.6	30.6
Heat Exchanger			Multi-Pass Cross-Finned Tube	
Condenser Fan	Type		Propeller Fan	
	Quantity		8	8
	Air Flow Rate		m³/min. 243×2+326×2	243+326×3
	Motor Output (Pole)		kW (0.34(8)×2)×2+(0.47(8)×2)×2	0.34(8)×2+(0.47(8)×2)×3
Main Refrigerant Piping	Liquid Line	mm φ19.05	φ19.05	
Heat Recovery System (3 Pipes)	Gas Line	mm φ44.45	φ44.45	

Notes:

- The cooling and heating performances are the values when combined with our specified indoor units.
 Cooling Operation Conditions
 Indoor Air Inlet Temperature: 27.0°C DB
 19.0°C WB
 Outdoor Air Inlet Temperature: 35°C DB
 Piping Length: 17.5 metres
 Piping Lift: 0 metres
 Heating Operation Conditions
 Indoor Air Inlet Temperature: 20.0°C DB
 Outdoor Air Inlet Temperature: 7.0°C DB
 6.0°C WB
 Piping Length: 17.5 metres
 Piping Lift: 0 metres
- The sound pressure is based on the following conditions.
 The above data is based on the cooling mode. In case of heating mode, the sound pressure level increases by approximately 1-2 dB.
 The above data was measured in an anechoic chamber so that reflected sound should be taken into consideration in the field.
- Except for the specified combination in the table (FSNP: 16-72HP class 45.0-201.0kW), there is no other combination of the base unit.
- The width of outer dimension, it is the value when each distance between the base outdoor units is specified to 20mm.



HP class

Model

		64	66	68	70	72	
		RAS-64FSNP	RAS-66FSNP	RAS-68FSNP	RAS-70FSNP	RAS-72FSNP	
Combination of Base Unit		RAS-16FSNP	RAS-16FSNP	RAS-16FSNP	RAS-16FSNP	RAS-18FSNP	
		RAS-16FSNP	RAS-16FSNP	RAS-16FSNP	RAS-18FSNP	RAS-18FSNP	
		RAS-16FSNP	RAS-16FSNP	RAS-18FSNP	RAS-18FSNP	RAS-18FSNP	
		RAS-16FSNP	RAS-18FSNP	RAS-18FSNP	RAS-18FSNP	RAS-18FSNP	
Power Supply		AC 3φ, [400V/50Hz] [380-415V/50Hz] [380V/60Hz] [220V/60Hz]					
Nominal Cooling Capacity	kW	179.0	184.0	190.0	196.0	201.0	
Nominal Heating Capacity	kW	202.0	207.0	213.0	220.0	225.0	
Cabinet	Colour	Natural Gray (1.0Y 8.5/0.5)					
	Munsell Code						
Outer Dimensions	H×W×D	mm					
		1,675×6,460×765	1,675×6,460×765	1,675×6,460×765	1,675×6,460×765	1,675×6,460×765	
Sound Level	Sound Power Level	dB(A)					
		91	91	92	91	92	
Sound Pressure Level		dB(A)					
		71	71	71	71	71	
Weight	Net Weight	400V/50Hz	kg				
		380-415V/50Hz	345+345+345+345	345+345+345+360	345+345+360+360	345+360+360+360	360+360+360+360
	Gross Weight	380V/60Hz	kg				
		220V/60Hz	340+340+340+340	340+340+340+355	340+340+355+355	340+355+355+355	355+355+355+355
Refrigerant	Type	R410A					
		Flow Control					
	Charge (before Shipment)	kg					
			40.0	40.6	41.2	41.8	42.4
Compressor	Type	Hermetic (Scroll)					
	Model	AA50PHD+AA50PHD					
		+AA50PHD+AA50PHD					
	Quantity	8					
		8	8	8	8	8	
Motor Output (Pole)	kW						
		(3.7(6)×2)×4	(3.7(6)×2)×3	(3.7(6)×2)×2	3.7(6)×2	(4.4(6)×2)×4	
Refrigeration Oil	Type	FVC68D					
	Charge	L/Unit					
Heat Exchanger	Multi-Pass Cross-Finned Tube						
		31.6	31.6	31.6	31.6	31.6	
Condenser Fan	Type	Propeller Fan					
	Quantity	8					
	Air Flow Rate	m ³ /min.					
		326×4	326×3+362	326×2+362×2	326+362×3	362×4	
Motor Output (Pole)	kW						
		(0.47(8)×2)×4	(0.47(8)×2)×3	(0.47(8)×2)×2	0.47(8)×2	(0.62(8)×2)×4	
Main Refrigerant Piping	Liquid Line	mm					
		φ19.05	φ19.05	φ22.2	φ22.2	φ22.2	
Heat Recovery System (3 Pipes)	Gas Line	mm					
		φ44.45	φ44.45	φ44.45	φ44.45	φ44.45	

Notes:

- The cooling and heating performances are the values when combined with our specified indoor units.

Cooling Operation Conditions	Heating Operation Conditions
Indoor Air Inlet Temperature: 27.0°C DB	Indoor Air Inlet Temperature: 20.0°C DB
19.0°C WB	Outdoor Air Inlet Temperature: 7.0°C DB
Outdoor Air Inlet Temperature: 35°C DB	6.0°C WB
Piping Length: 17.5 metres	Piping Length: 17.5 metres
Piping Lift: 0 metres	Piping Lift: 0 metres
- The sound pressure is based on the following conditions.

The above data is based on the cooling mode. In case of heating mode, the sound pressure level increases by approximately 1-2 dB.

The above data was measured in an anechoic chamber so that reflected sound should be taken into consideration in the field.
- Except for the specified combination in the table (FSNP: 16-72HP class 45.0-201.0kW), there is no other combination of the base unit.
- The width of outer dimension, it is the value when each distance between the base outdoor units is specified to 20mm.

SPECIFICATIONS

Space saving model: FSNS series



HP class

8 10 12 14 16 18

Model

RAS-8FSNS RAS-10FSNS RAS-12FSNS RAS-14FSNS RAS-16FSNS RAS-18FSNS

Power Supply		AC 3φ, [400V/50Hz] [380-415V/50Hz] [380V/60H] [220V/60Hz]							
Nominal Cooling Capacity		kW	22.4	28.0	33.5	40.0	45.0	50.0	
Nominal Heating Capacity		kW	25.0	31.5	37.5	45.0	50.0	56.0	
Cabinet	Colour	Munsell Code	Natural Gray (1.0Y 8.5/0.5)						
	Outer Dimensions	H×W×D	mm	1,675×950×765	1,675×950×765	1,675×950×765	1,675×1,210×765	1,675×1,210×765	1,675×1,210×765
Sound Level	Sound Power Level		dB(A)	80	82	82	85	85	86
	Sound Pressure Level		dB(A)	58	60	59	63	63	65
Weight	Net Weight	400V/50Hz	kg	190	190	210	268	310	311
		380-415V/50Hz	kg						
	380V/60Hz	kg	185	185	205	263	305	306	
	Gross Weight	400V/50Hz	kg	206	206	226	286	328	329
380-415V/50Hz		kg							
380V/60Hz	kg	201	201	221	281	323	324		
Refrigerant	Type		R410A						
	Flow Control		Micro-Computer Control Expansion Valve						
	Charge (before Shipment)	kg	5.0	5.0	7.2	8.9	9.9	10.7	
Compressor	Type		Hermetic (Scroll)						
	Model		AA50PHD	AA50PHD	DC80PHD	DC80PHD	AA50PHD +AA50PHD	AA50PHD +AA50PHD	
	Quantity		1	1	1	1	2	2	
Refrigeration Oil	Motor Output (Pole)	kW	3.3(6)	4.3(6)	5.4(6)	8.0(6)	4.5(6)×2	5.0(6)×2	
	Type		FVC68D						
Heat Exchanger	Charge	L/Unit	6.0	6.0	6.0	6.9	7.9	7.9	
	Type		Multi-Pass Cross-Finned Tube						
Condenser Fan	Type		Propeller Fan						
	Quantity		1	1	1	2	2	2	
	Air Flow Rate	m³/min.	165	170	190	239	256	256	
	Motor Output (Pole)	kW	0.26(8)	0.28(8)	0.42(8)	0.33(8)×2	0.39(8)×2	0.39(8)×2	
Main Refrigerant Piping	Liquid Line	mm	φ9.52	φ9.52	φ12.7	φ12.7	φ12.7	φ15.88	
Heat Recovery System (3 Pipes)	Gas Line	mm	φ19.05	φ22.2	φ25.4	φ25.4	φ28.58	φ28.58	
Package	Dimensions	H×W×D	mm	1,800×1,030×810	1,800×1,030×810	1,800×1,030×810	1,800×1,290×810	1,800×1,290×810	1,800×1,290×810
	Measurement	m³	1.5	1.5	1.5	1.9	1.9	1.9	

Notes:

- The cooling and heating performances are the values when combined with our specified indoor units.

Cooling Operation Conditions Indoor Air Inlet Temperature: 27.0°C DB 19.0°C WB Outdoor Air Inlet Temperature: 35°C DB Piping Length: 7.5 metres Piping Lift: 0 metres	Heating Operation Conditions Indoor Air Inlet Temperature: 20.0°C DB Outdoor Air Inlet Temperature: 7.0°C DB 6.0°C WB Piping Length: 7.5 metres Piping Lift: 0 metres
---	---
- The sound pressure is based on the following conditions.
 The above data is based on the cooling mode. In case of heating mode, the sound pressure level increases by approximately 1~2 dB.
 The above data was measured in an anechoic chamber so that reflected sound should be taken into consideration in the field.
- The width of outer dimension, it is the value when each distance between the base outdoor units is specified to 20mm.



HP class		20	22	24		
Model		RAS-20FSNS	RAS-22FSNS	RAS-24FSNS		
Power Supply		AC 3φ, [400V/50Hz] [380-415V/50Hz] [380V/60Hz] [220V/60Hz]				
Nominal Cooling Capacity		kW	56.0	61.5	67.0	
Nominal Heating Capacity		kW	63.0	69.0	77.5	
Cabinet	Colour	Munsell Code	Natural Gray (1.0Y 8.5/0.5)			
	Outer Dimensions	H×W×D	mm	1,675×1,600×765	1,675×1,600×765	1,675×1,600×765
Sound Level	Sound Power Level		dB(A)	86	84	86
	Sound Pressure Level		dB(A)	65	64	66
Weight	Net Weight	400V/50Hz	kg	350	364	365
		380-415V/50Hz	kg	350	364	365
	380V/60Hz	kg	345	359	360	
	220V/60Hz	kg	345	359	360	
Gross Weight	400V/50Hz	kg	370	384	385	
		380-415V/50Hz	kg	370	384	385
	380V/60Hz	kg	365	379	380	
	220V/60Hz	kg	365	379	380	
Refrigerant	Type		R410A			
	Flow Control		Micro-Computer Control Expansion Valve			
	Charge (before Shipment)	kg	11.3	11.3	11.6	
Compressor	Type		Hermetic (Scroll)			
	Model		AA50PHD+AA50PHD	DC80PHD+DC80PHD	DC80PHD+DC80PHD	
	Quantity		2	2	2	
	Motor Output (Pole)	kW	5.5(6)×2	6.7(6)×2	7.1(6)×2	
Refrigeration Oil	Type		FVC68D			
	Charge	L/Unit	8.4	8.4	8.4	
Heat Exchanger		Multi-Pass Cross-Finned Tube				
Condenser Fan	Type		Propeller Fan			
	Quantity		2	2	2	
	Air Flow Rate	m ³ /min.	329	329	348	
	Motor Output (Pole)	kW	0.48(8)×2	0.48(8)×2	0.56(8)×2	
Main Refrigerant Piping	Liquid Line	mm	φ15.88	φ15.88	φ15.88	
Heat Recovery System (3 Pipes)	Gas Line	mm	φ28.58	φ28.58	φ28.58	
Package	Dimensions	H×W×D	mm	1,800×1,680×810	1,800×1,680×810	1,800×1,680×810
	Measurement	m ³	2.4	2.4	2.4	

Notes:

- The cooling and heating performances are the values when combined with our specified indoor units.

Cooling Operation Conditions	Heating Operation Conditions
Indoor Air Inlet Temperature: 27.0°C DB	Indoor Air Inlet Temperature: 20.0°C DB
19.0°C WB	Outdoor Air Inlet Temperature: 7.0°C DB
Outdoor Air Inlet Temperature: 35°C DB	6.0°C WB
Piping Length: 10.0 metres	Piping Length: 10.0 metres
Piping Lift: 0 metres	Piping Lift: 0 metres
- The sound pressure is based on the following conditions.

The above data is based on the cooling mode. In case of heating mode, the sound pressure level increases by approximately 1~2 dB.

The above data was measured in an anechoic chamber so that reflected sound should be taken into consideration in the field.
- The width of outer dimension, it is the value when each distance between the base outdoor units is specified to 20mm.

SPECIFICATIONS

Space saving model: FSNS series



HP class

26 28 30 32 34 36

Model

RAS-26FSNS RAS-28FSNS RAS-30FSNS RAS-32FSNS RAS-34FSNS RAS-36FSNS

Combination of Base Unit			RAS-12FSNS RAS-14FSNS	RAS-16FSNS RAS-12FSNS	RAS-12FSNS RAS-18FSNS	RAS-14FSNS RAS-18FSNS	RAS-16FSNS RAS-18FSNS	RAS-18FSNS RAS-18FSNS	
Power Supply			AC 3φ, [400V/50Hz] [380-415V/50Hz] [380V/60Hz] [220V/60Hz]						
Nominal Cooling Capacity			kW	73.0	77.5	85.0	90.0	95.0	100.0
Nominal Heating Capacity			kW	82.5	90.0	95.0	100.0	106.0	112.0
Cabinet	Colour	Munsell Code	Natural Gray (1.0Y 8.5/0.5)						
	Outer Dimensions	H×W×D	mm	1,675×2,180×765	1,675×2,180×765	1,675×2,180×765	1,675×2,440×765	1,675×2,440×765	1,675×2,440×765
Sound Level	Sound Power Level		dB(A)	87	87	87	89	89	89
	Sound Pressure Level		dB(A)	64.5	64.5	66	67	67	68
Weight	Net Weight	400V/50Hz 380-415V/50Hz 380V/60Hz	kg	210+268	210+310	210+311	268+311	310+311	311+311
		220V/60Hz	kg	205+263	205+305	205+306	263+306	305+306	306+306
	Gross Weight	400V/50Hz 380-415V/50Hz 380V/60Hz	kg	226+286	226+328	226+329	286+329	328+329	329+329
		220V/60Hz	kg	221+281	221+323	221+324	281+324	323+324	324+324
Refrigerant	Type		R410A						
	Flow Control		Micro-Computer Control Expansion Valve						
	Charge (before Shipment)		kg	16.1	17.1	17.9	19.6	20.6	21.4
Compressor	Type		Hermetic (Scroll)						
	Model		DC80PHD+DC80PHD DC80PHD+AA50PHD+AA50PHD DC80PHD+AA50PHD+AA50PHD DC80PHD+AA50PHD+AA50PHD AA50PHD+AA50PHD+AA50PHD AA50PHD+AA50PHD+AA50PHD						
	Quantity		2 3 3 3 4 4						
	Motor Output (Pole)		kW	5.4(6)×1+8.0(6)×1	5.4(6)×1+4.5(6)×2	5.4(6)×1+5.0(6)×2	8.0(6)×1+5.0(6)×2	4.5(6)×2+5.0(6)×2	5.0(6)×2+5.0(6)×2
Refrigeration Oil	Type		FVC68D						
	Charge		L/Unit	12.9	13.9	13.9	14.8	15.8	15.8
Heat Exchanger			Multi-Pass Cross-Finned Tube						
Condenser Fan	Type		Propeller Fan						
	Quantity		3 3 3 4 4 4						
	Air Flow Rate		m³/min.	190+239	190+256	190+256	239+256	256×2	256×2
	Motor Output (Pole)		kW	0.42(8) +0.33(8)×2	0.42(8) +0.39(8)×2	0.42(8) +0.39(8)×2	0.33(8)×2 +0.39(8)×2	0.39(8)×2 +0.39(8)×2	0.39(8)×2 +0.39(8)×2
Main Refrigerant Piping	Liquid Line		mm	φ19.05	φ19.05	φ19.05	φ19.05	φ19.05	φ19.05
Heat Recovery System (3 Pipes)	Gas Line		mm	φ31.75	φ31.75	φ31.75	φ31.75	φ31.75	φ38.1

Notes:

- The cooling and heating performances are the values when combined with our specified indoor units.
Cooling Operation Conditions
Indoor Air Inlet Temperature: 27.0°C DB
19.0°C WB
Outdoor Air Inlet Temperature: 35°C DB
Piping Length: 10.0 metres (RAS-26~30FSNS),
12.5 metres (RAS-32~36FSNS)
Piping Lift: 0 metres
- The sound pressure is based on the following conditions.
The above data is based on the cooling mode. In case of heating mode, the sound pressure level increases by approximately 1-2 dB.
The above data was measured in an anechoic chamber so that reflected sound should be taken into consideration in the field.
- Except for the specified combination in the table (FSNS: 26~96HP class 73.0~268.0kW), there is no other combination of the base unit.
- The width of outer dimension, it is the value when each distance between the base outdoor units is specified to 20mm.



HP class

Model

			38	40	42	44	46	48
			RAS-38FSNS	RAS-40FSNS	RAS-42FSNS	RAS-44FSNS	RAS-46FSNS	RAS-48FSNS
Combination of Base Unit			RAS-14FSNS RAS-24FSNS	RAS-18FSNS RAS-22FSNS	RAS-18FSNS RAS-24FSNS	RAS-22FSNS RAS-22FSNS	RAS-22FSNS RAS-24FSNS	RAS-24FSNS RAS-24FSNS
Power Supply			AC 3φ, [400V/50Hz] [380-415V/50Hz] [380V/60Hz] [220V/60Hz]					
Nominal Cooling Capacity			kW 106.0	112.0	118.0	122.0	128.0	136.0
Nominal Heating Capacity			kW 118.0	125.0	132.0	140.0	145.0	150.0
Cabinet	Colour	Munsell Code	Natural Gray (1.0Y 8.5/0.5)					
	Outer Dimensions	H×W×D	mm 1,675×2,830×765	1,675×2,830×765	1,675×2,830×765	1,675×3,220×765	1,675×3,220×765	1,675×3,220×765
Sound Level	Sound Power Level	dB(A)	89	88	89	87	88	89
	Sound Pressure Level	dB(A)	68	67.5	68.5	67	68	69
Weight	Net Weight	400V/50Hz	kg 268+365	311+364	311+365	364+364	364+365	365+365
		380-415V/50Hz	kg 263+360	306+359	306+360	359+359	359+360	360+360
	Gross Weight	400V/50Hz	kg 286+385	329+384	329+385	384+384	384+385	385+385
		380-415V/50Hz	kg 281+380	324+379	324+380	379+379	379+380	380+380
Refrigerant	Type	R410A						
	Flow Control	Micro-Computer Control Expansion Valve						
	Charge (before Shipment)	kg 20.5	22.0	22.3	22.6	22.9	23.2	
Compressor	Type	Hermetic (Scroll)						
	Model	DC80PHD+DC80PHD +DC80PHD	AA50PHD+AA50PHD +DC80PHD+DC80PHD	AA50PHD+AA50PHD +DC80PHD+DC80PHD	DC80PHD+DC80PHD +DC80PHD+DC80PHD	DC80PHD+DC80PHD +DC80PHD+DC80PHD	DC80PHD+DC80PHD +DC80PHD+DC80PHD	
	Quantity	3	4	4	4	4	4	
	Motor Output (Pole)	kW 8.0(6)×1+7.1(6)×2	5.0(6)×2+6.7(6)×2	5.0(6)×2+7.1(6)×2	6.7(6)×2+6.7(6)×2	6.7(6)×2+7.1(6)×2	7.1(6)×2+7.1(6)×2	
Refrigeration Oil	Type	FVC68D						
	Charge	L/Unit 15.3	16.3	16.3	16.8	16.8	16.8	
Heat Exchanger			Multi-Pass Cross-Finned Tube					
Condenser Fan	Type	Propeller Fan						
	Quantity	4	4	4	4	4	4	
	Air Flow Rate	m³/min. 239+348	256+329	256+348	329×2	329+348	348×2	
	Motor Output (Pole)	kW 0.33(8)×2 +0.56(8)×2	0.39(8)×2 +0.48(8)×2	0.39(8)×2 +0.56(8)×2	0.48(8)×2 +0.48(8)×2	0.48(8)×2 +0.56(8)×2	0.56(8)×2 +0.56(8)×2	
Main Refrigerant Piping	Liquid Line	mm φ19.05	φ19.05	φ19.05	φ19.05	φ19.05	φ19.05	
Heat Recovery System (3 Pipes)	Gas Line	mm φ38.1	φ38.1	φ38.1	φ38.1	φ38.1	φ38.1	

Notes:

- The cooling and heating performances are the values when combined with our specified indoor units.
 Cooling Operation Conditions
 Indoor Air Inlet Temperature: 27.0°C DB
 19.0°C WB
 Outdoor Air Inlet Temperature: 35°C DB
 Piping Length: 12.5 metres (RAS-38~44FSNS),
 15.0 metres (RAS-46~48FSNS)
 Piping Lift: 0 metres
 Heating Operation Conditions
 Indoor Air Inlet Temperature: 20.0°C DB
 Outdoor Air Inlet Temperature: 7.0°C DB
 6.0°C WB
 Piping Length: 12.5 metres (RAS-38~44FSNS),
 15.0 metres (RAS-46~48FSNS)
 Piping Lift: 0 metres
- The sound pressure is based on the following conditions.
 The above data is based on the cooling mode. In case of heating mode, the sound pressure level increases by approximately 1-2 dB.
 The above data was measured in an anechoic chamber so that reflected sound should be taken into consideration in the field.
- Except for the specified combination in the table (FSNS: 26~96HP class 73.0~268.0kW), there is no other combination of the base unit.
- The width of outer dimension, it is the value when each distance between the base outdoor units is specified to 20mm.

SET FREE Σ

SPECIFICATIONS

SPECIFICATIONS

Space saving model: FSNS series



HP class

50 52 54 56 58 60

Model

RAS-50FSNS RAS-52FSNS RAS-54FSNS RAS-56FSNS RAS-58FSNS RAS-60FSNS

Combination of Base Unit			RAS-14FSNS RAS-18FSNS RAS-18FSNS	RAS-16FSNS RAS-18FSNS RAS-18FSNS	RAS-18FSNS RAS-18FSNS RAS-18FSNS	RAS-14FSNS RAS-18FSNS RAS-24FSNS	RAS-18FSNS RAS-18FSNS RAS-22FSNS	RAS-18FSNS RAS-18FSNS RAS-24FSNS	
Power Supply			AC 3φ, [400V/50Hz] [380-415V/50Hz] [380V/60Hz] [220V/60Hz]						
Nominal Cooling Capacity			kW	140.0	145.0	150.0	157.0	162.0	167.0
Nominal Heating Capacity			kW	155.0	160.0	165.0	176.0	181.0	188.0
Cabinet	Colour	Munsell Code	Natural Gray (1.0Y 8.5/0.5)						
	Outer Dimensions	H×W×D	mm	1,675×3,670×765	1,675×3,670×765	1,675×3,670×765	1,675×4,060×765	1,675×4,060×765	1,675×4,060×765
Sound Level	Sound Power Level		dB(A)	90	90	91	90	90	91
	Sound Pressure Level		dB(A)	69	69	70	69.5	69.5	70
Weight	Net Weight	400V/50Hz 380-415V/50Hz 380V/60Hz	kg	268+311+311	310+311+311	311+311+311	268+311+365	311+311+364	311+311+365
		220V/60Hz	kg	263+306+306	305+306+306	306+306+306	263+306+360	306+306+359	306+306+360
	Gross Weight	400V/50Hz 380-415V/50Hz 380V/60Hz	kg	286+329+329	328+329+329	329+329+329	286+329+385	329+329+384	329+329+385
220V/60Hz		kg	281+324+324	323+324+324	324+324+324	281+324+380	324+324+379	324+324+380	
Refrigerant	Type		R410A						
	Flow Control		Micro-Computer Control Expansion Valve						
	Charge (before Shipment)	kg	30.3	31.3	32.1	31.2	32.7	33.0	
Compressor	Type		Hermetic (Scroll)						
	Model		DC80PHD+AA50PHD +AA50PHD+AA50PHD +AA50PHD						
	Quantity		5 6 6 5 6 6						
	Motor Output (Pole)		kW	8.0(6)×1+5.0(6)×2 +5.0(6)×2	4.5(6)×2+5.0(6)×2 +5.0(6)×2	5.0(6)×2+5.0(6)×2 +5.0(6)×2	8.0(6)+5.0(6)×2 +7.1(6)×2	(5.0(6)×2)×2 +6.7(6)×2	(5.0(6)×2)×2 +7.1(6)×2
Refrigeration Oil	Type		FVC68D						
	Charge	L/Unit	22.7	23.7	23.7	23.2	24.2	24.2	
Heat Exchanger			Multi-Pass Cross-Finned Tube						
Condenser Fan	Type		Propeller Fan						
	Quantity		6	6	6	6	6	6	
	Air Flow Rate	m³/min.	239+256×2	256×3	256×3	239+256+348	256+256+329	256+256+348	
	Motor Output (Pole)	kW	0.33(8)×2+0.39(8)×2 +0.39(8)×2	0.39(8)×2+0.39(8)×2 +0.39(8)×2	0.39(8)×2+0.39(8)×2 +0.39(8)×2	0.33(8)×2+0.39(8)×2 +0.56(8)×2	(0.39(8)×2)×2 +0.48(8)×2	(0.39(8)×2)×2 +0.56(8)×2	
Main Refrigerant Piping	Liquid Line	mm	φ19.05	φ19.05	φ19.05	φ19.05	φ19.05	φ19.05	
Heat Recovery System (3 Pipes)	Gas Line	mm	φ38.1	φ38.1	φ38.1	φ44.45	φ44.45	φ44.45	

Notes:

- The cooling and heating performances are the values when combined with our specified indoor units.

Cooling Operation Conditions	Indoor Air Inlet Temperature: 27.0°C DB 19.0°C WB	Heating Operation Conditions	Indoor Air Inlet Temperature: 20.0°C DB Outdoor Air Inlet Temperature: 7.0°C DB 6.0°C WB
Outdoor Air Inlet Temperature: 35°C DB	Piping Length: 15.0 metres (RAS-50~56FSNS), 17.5 metres (RAS-58~60FSNS)	Piping Length: 15.0 metres (RAS-50~56FSNS), 17.5 metres (RAS-58~60FSNS)	Piping Lift: 0 metres
- The sound pressure is based on the following conditions.
 The above data is based on the cooling mode. In case of heating mode, the sound pressure level increases by approximately 1~2 dB.
 The above data was measured in an anechoic chamber so that reflected sound should be taken into consideration in the field.
- Except for the specified combination in the table (FSNS: 26~96HP class 73.0~268.0kW), there is no other combination of the base unit.
- The width of outer dimension, it is the value when each distance between the base outdoor units is specified to 20mm.



HP class

Model

		62	64	66	68	70	72				
		RAS-62FSNS	RAS-64FSNS	RAS-66FSNS	RAS-68FSNS	RAS-70FSNS	RAS-72FSNS				
Combination of Base Unit		RAS-14FSNS RAS-24FSNS RAS-24FSNS	RAS-18FSNS RAS-22FSNS RAS-24FSNS	RAS-18FSNS RAS-24FSNS RAS-24FSNS	RAS-22FSNS RAS-22FSNS RAS-24FSNS	RAS-22FSNS RAS-24FSNS RAS-24FSNS	RAS-24FSNS RAS-24FSNS RAS-24FSNS				
Power Supply		AC 3φ, [400V/50Hz] [380-415V/50Hz] [380V/60H] [220V/60Hz]									
Nominal Cooling Capacity		kW		174.0	179.0	184.0	190.0	196.0	201.0		
Nominal Heating Capacity		kW		196.0	202.0	207.0	213.0	220.0	225.0		
Cabinet		Colour	Natural Gray (1.0Y 8.5/0.5)								
		Munsell Code									
		Outer Dimensions	H×W×D	mm	1,675×4,450×765	1,675×4,450×765	1,675×4,450×765	1,675×4,840×765	1,675×4,840×765	1,675×4,840×765	
Sound Level		Sound Power Level		dB(A)	90	90	91	90	90	91	
		Sound Pressure Level		dB(A)	70	70	70.5	69.5	70	71	
Weight		Net Weight		400V/50Hz 380-415V/50Hz 380V/60Hz	kg	268+365+365	311+364+365	311+365+365	364+364+365	364+365+365	365+365+365
				220V/60Hz	kg	263+360+360	306+359+360	306+360+360	359+359+360	359+360+360	360+360+360
		Gross Weight		400V/50Hz 380-415V/50Hz 380V/60Hz	kg	286+385+385	329+384+385	329+385+385	384+384+385	384+385+385	385+385+385
				220V/60Hz	kg	281+380+380	324+379+380	324+380+380	379+379+380	379+380+380	380+380+380
Refrigerant		Type		R410A							
		Flow Control		Micro-Computer Control Expansion Valve							
		Charge (before Shipment)		kg	32.1	33.6	33.9	34.2	34.5	34.8	
Compressor		Type		Hermetic (Scroll)							
		Model		DC80PHD+DC80PHD +DC80PHD+DC80PHD +DC80PHD							
				AA50PHD+AA50PHD +DC80PHD+DC80PHD +DC80PHD+DC80PHD							
				AA50PHD+AA50PHD +DC80PHD+DC80PHD +DC80PHD+DC80PHD							
				DC80PHD+DC80PHD +DC80PHD+DC80PHD +DC80PHD+DC80PHD							
				DC80PHD+DC80PHD +DC80PHD+DC80PHD +DC80PHD+DC80PHD							
		Quantity		5							
		Motor Output (Pole)		kW	8.0(6) +(7.1(6)×2)×2	5.0(6)×2+6.7(6)×2 +7.1(6)×2	5.0(6)×2 +(7.1(6)×2)×2	(6.7(6)×2)×2 +7.1(6)×2	6.7(6)×2 +(7.1(6)×2)×2	(7.1(6)×2)×3	
Refrigeration Oil		Type		FVC68D							
		Charge		L/Unit	23.7	24.7	24.7	25.2	25.2	25.2	
Heat Exchanger		Multi-Pass Cross-Finned Tube									
Condenser Fan		Type		Propeller Fan							
		Quantity		6							
		Air Flow Rate		m ³ /min.	239+348+348	256+329+348	256+348+348	329+329+348	329+348×2	348×3	
		Motor Output (Pole)		kW	0.33(8)×2 +(0.56(8)×2)×2	0.39(8)×2+0.48(8)×2 +0.56(8)×2	0.39(8)×2 +(0.56(8)×2)×2	(0.48(8)×2)×2 +0.56(8)×2	0.48(8)×2 +(0.56(8)×2)×2	(0.56(8)×2)×3	
Main Refrigerant Piping		Liquid Line		mm	φ19.05	φ19.05	φ19.0	φ22.2	φ22.2	φ22.2	
Heat Recovery System (3 Pipes)		Gas Line		mm	φ44.45	φ44.45	φ44.45	φ44.45	φ44.45	φ44.45	

Notes:

- The cooling and heating performances are the values when combined with our specified indoor units.
 Cooling Operation Conditions: Indoor Air Inlet Temperature: 27.0°C DB, 19.0°C WB
 Heating Operation Conditions: Indoor Air Inlet Temperature: 20.0°C DB, Outdoor Air Inlet Temperature: 7.0°C DB, 6.0°C WB
 Outdoor Air Inlet Temperature: 35°C DB
 Piping Length: 17.5 metres
 Piping Lift: 0 metres
- The sound pressure is based on the following conditions.
 The above data is based on the cooling mode. In case of heating mode, the sound pressure level increases by approximately 1-2 dB.
 The above data was measured in an anechoic chamber so that reflected sound should be taken into consideration in the field.
- Except for the specified combination in the table (FSNS: 26-96HP class 73.0-268.0kW), there is no other combination of the base unit.
- The width of outer dimension, it is the value when each distance between the base outdoor units is specified to 20mm.

SPECIFICATIONS

Space saving model: FSNS series



HP class

Model

		74	76	78	80	82	84		
		RAS-74FSNS	RAS-76FSNS	RAS-78FSNS	RAS-80FSNS	RAS-82FSNS	RAS-84FSNS		
Combination of Base Unit		RAS-14FSNS RAS-18FSNS RAS-18FSNS RAS-24FSNS	RAS-18FSNS RAS-18FSNS RAS-18FSNS RAS-22FSNS	RAS-18FSNS RAS-18FSNS RAS-18FSNS RAS-24FSNS	RAS-14FSNS RAS-18FSNS RAS-24FSNS RAS-24FSNS	RAS-16FSNS RAS-18FSNS RAS-24FSNS RAS-24FSNS	RAS-18FSNS RAS-18FSNS RAS-24FSNS RAS-24FSNS		
Power Supply		AC 3φ, [400V/50Hz] [380-415V/50Hz] [380V/60Hz] [220V/60Hz]							
Nominal Cooling Capacity		kW		207.0	212.0	217.0	224.0	230.0	234.0
Nominal Heating Capacity		kW		232.0	237.0	244.0	254.0	261.0	267.0
Cabinet	Colour	Natural Gray (1.0Y 8.5/0.5)							
	Munsell Code	Natural Gray (1.0Y 8.5/0.5)							
Sound Level	Outer Dimensions	H×W×D	mm	1,675×5,290×765	1,675×5,290×765	1,675×5,290×765	1,675×5,680×765	1,675×5,680×765	1,675×5,680×765
	Sound Power Level	dB(A)	92	92	92	92	92	92	92
Weight	Sound Pressure Level	dB(A)	71	71	71.5	71	71	71	71.5
	Net Weight	kg	268+311+311+365	311+311+311+364	311+311+311+365	268+311+365+365	310+311+365+365	311+311+365+365	311+311+365+365
Refrigerant	Gross Weight	kg	263+306+306+360	306+306+306+359	306+306+306+360	263+306+360+360	305+306+360+360	306+306+360+360	306+306+360+360
	Type	R410A							
Compressor	Flow Control	Micro-Computer Control Expansion Valve							
	Charge (before Shipment)	kg	41.9	43.4	43.7	42.8	43.8	44.6	
Condenser Fan	Type	Hermetic (Scroll)							
	Model	DC80PHD+AA50PHD +AA50PHD+AA50PHD +AA50PHD+DC80PHD +DC80PHD	AA50PHD+AA50PHD +AA50PHD+AA50PHD +AA50PHD+AA50PHD +DC80PHD+DC80PHD	AA50PHD+AA50PHD +AA50PHD+AA50PHD +AA50PHD+AA50PHD +DC80PHD+DC80PHD	DC80PHD+AA50PHD +AA50PHD+DC80PHD +DC80PHD+DC80PHD +DC80PHD	AA50PHD+AA50PHD +AA50PHD+AA50PHD +DC80PHD+DC80PHD +DC80PHD+DC80PHD	AA50PHD+AA50PHD +AA50PHD+AA50PHD +DC80PHD+DC80PHD +DC80PHD+DC80PHD		
	Quantity	7	8	8	7	8	8		
	Motor Output (Pole)	kW	8.0(6)+[5.0(6)×2]×2 +7.1(6)×2	(5.0(6)×2)×3 +6.7(6)×2	(5.0(6)×2)×3 +7.1(6)×2	8.0(6)+5.0(6)×2 +7.1(6)×2	4.5(6)×2+5.0(6)×2 +7.1(6)×2	(5.0(6)×2)×2 +7.1(6)×2	
Refrigeration Oil	Type	FVC68D							
	Charge	L/Unit	31.1	32.1	32.1	31.6	32.6	32.6	
Heat Exchanger		Multi-Pass Cross-Finned Tube							
Main Refrigerant Piping	Type	Propeller Fan							
	Quantity	8	8	8	8	8	8		
	Air Flow Rate	m³/min.	239+256×2+348	256×3+329	256×3+348	239+256+348×2	256+256+348×2	256×2+348×2	
	Motor Output (Pole)	kW	0.33(8)×2+(0.39(8)×2)×2 +0.56(8)×2	(0.39(8)×2)×3 +0.48(8)×2	(0.39(8)×2)×3 +0.56(8)×2	0.33(8)×2+0.39(8)×2 +0.56(8)×2	0.39(8)×2+0.39(8)×2 +0.56(8)×2	(0.39(8)×2)×2 +0.56(8)×2	
Heat Recovery System (3 Pipes)	Liquid Line	mm	φ22.2	φ22.2	φ22.2	φ22.2	φ22.2	φ22.2	
	Gas Line	mm	φ50.8	φ50.8	φ50.8	φ50.8	φ50.8	φ50.8	

Notes:

- The cooling and heating performances are the values when combined with our specified indoor units.
Cooling Operation Conditions: Indoor Air Inlet Temperature: 27.0°C DB, 19.0°C WB
Heating Operation Conditions: Indoor Air Inlet Temperature: 20.0°C DB, Outdoor Air Inlet Temperature: 7.0°C DB, 6.0°C WB
Outdoor Air Inlet Temperature: 35°C DB
Piping Length: 20.0 metres
Piping Lift: 0 metres
- The sound pressure is based on the following conditions.
The above data is based on the cooling mode. In case of heating mode, the sound pressure level increases by approximately 1-2 dB.
The above data was measured in an anechoic chamber so that reflected sound should be taken into consideration in the field.
- Except for the specified combination in the table (FSNS: 26-96HP class 73.0-268.0kW), there is no other combination of the base unit.
- The width of outer dimension, it is the value when each distance between the base outdoor units is specified to 20mm.



HP class

Model

		86	88	90	92	94	96		
		RAS-86FSNS	RAS-88FSNS	RAS-90FSNS	RAS-92FSNS	RAS-94FSNS	RAS-96FSNS		
Combination of Base Unit		RAS-14FSNS	RAS-16FSNS	RAS-18FSNS	RAS-22FSNS	RAS-22FSNS	RAS-24FSNS		
		RAS-24FSNS	RAS-24FSNS	RAS-24FSNS	RAS-22FSNS	RAS-24FSNS	RAS-24FSNS		
		RAS-24FSNS	RAS-24FSNS	RAS-24FSNS	RAS-24FSNS	RAS-24FSNS	RAS-24FSNS		
Power Supply		AC 3φ, [400V/50Hz] [380-415V/50Hz] [380V/60H] [220V/60Hz]							
Nominal Cooling Capacity		kW	241.0	246.0	251.0	258.0	263.0	268.0	
Nominal Heating Capacity		kW	275.0	282.0	287.0	293.0	299.0	305.0	
Cabinet	Colour	Munsell Code	Natural Gray (1.0Y 8.5/0.5)						
	Outer Dimensions	H×W×D	mm	1,675×6,070×765	1,675×6,070×765	1,675×6,070×765	1,675×6,460×765	1,675×6,460×765	1,675×6,460×765
Sound Level	Sound Power Level		dB(A)	92	92	92	92	92	92
	Sound Pressure Level		dB(A)	71.5	71.5	72	72	71.5	72
Weight	Net Weight	400V/50Hz	kg	268+365+365+365	310+365+365+365	311+365+365+365	364+364+365+365	364+365+365+365	365+365+365+365
		380-415V/50Hz	kg	263+360+360+360	305+360+360+360	306+360+360+360	359+359+360+360	359+360+360+360	360+360+360+360
	Gross Weight	400V/50Hz	kg	286+385+385+385	328+385+385+385	329+385+385+385	384+384+385+385	384+385+385+385	385+385+385+385
		380V/60Hz	kg	281+380+380+380	323+380+380+380	324+380+380+380	379+379+380+380	379+380+380+380	380+380+380+380
Refrigerant	Type		R410A						
	Flow Control		Micro-Computer Control Expansion Valve						
	Charge (before Shipment)	kg	43.7	44.7	45.5	45.8	46.1	46.4	
Compressor	Type		Hermetic (Scroll)						
	Model		DC80PHD+DC80PHD AA50PHD+AA50PHD AA50PHD+AA50PHD DC80PHD+DC80PHD DC80PHD+DC80PHD DC80PHD+DC80PHD DC80PHD+DC80PHD						
	Quantity		7 8 8 8 8 8						
	Motor Output (Pole)		kW	8.0(6) +(7.1(6)×2)×3	4.5(6)×2 +(7.1(6)×2)×3	5.0(6)×2 +(7.1(6)×2)×3	(6.7(6)×2)×2 +(7.1(6)×2)×2	6.7(6)×2 +(7.1(6)×2)×3	(7.1(6)×2)×4
	Refrigeration Oil		Type	FVC68D					
Charge		L/Unit	32.1	33.1	33.1	33.6	33.6	33.6	
Heat Exchanger		Multi-Pass Cross-Finned Tube							
Condenser Fan	Type		Propeller Fan						
	Quantity		8 8 8 8 8 8						
	Air Flow Rate		m³/min.	239+348×3	256+348×3	256+348×3	329×2+348×2	329+348×3	348×4
	Motor Output (Pole)		kW	0.33(8)×2 +(0.56(8)×2)×3	0.39(8)×2 +(0.56(8)×2)×3	0.39(8)×2 +(0.56(8)×2)×3	(0.48(8)×2)×2 +(0.56(8)×2)×2	0.48(8)×2 +(0.56(8)×2)×3	(0.56(8)×2)×4
Main Refrigerant Piping	Liquid Line	mm	φ22.2 (3/4)	φ22.2 (3/4)	φ25.4 (1)	φ25.4 (1)	φ25.4 (1)	φ25.4 (1)	
Heat Recovery System (3 Pipes)	Gas Line	mm	φ50.8 (2)	φ50.8 (2)	φ50.8 (2)	φ50.8 (2)	φ50.8 (2)	φ50.8 (2)	

- Notes:
- The cooling and heating performances are the values when combined with our specified indoor units.
Cooling Operation Conditions: Indoor Air Inlet Temperature: 27.0°C DB, 19.0°C WB
Heating Operation Conditions: Indoor Air Inlet Temperature: 20.0°C DB, Outdoor Air Inlet Temperature: 7.0°C DB, 6.0°C WB
Outdoor Air Inlet Temperature: 35°C DB
Piping Length: 22.5 metres
Piping Lift: 0 metres
 - The sound pressure is based on the following conditions.
The above data is based on the cooling mode. In case of heating mode, the sound pressure level increases by approximately 1-2 dB.
The above data was measured in an anechoic chamber so that reflected sound should be taken into consideration in the field.
 - Except for the specified combination in the table (FSNS: 26-96HP class 73.0-268.0kW), there is no other combination of the base unit.
 - The width of outer dimension, it is the value when each distance between the base outdoor units is specified to 20mm.

OPTIONAL PARTS FOR HEAT PUMP TYPE

PIPING CONNECTION KIT

Piping connection kit for the divergence between outdoor units

Model	Applicable ODU		Connectivity Number	Remarks
	HP class			
	FSNP series	FSNS series		
MC-NP20SA1	20-24	-	2	for Gas: 1 for Liquid: 1
MC-NP21SA1	26-36	26-48	2	
MC-NP30SA1	38-54	50-54	3	for Gas: 2 for Liquid: 2
MC-NP31SA	-	56-72	3	for Gas: 2 for Liquid: 2
MC-NP40SA	56-72	74-96	4	for Gas: 3 for Liquid: 3

NOTE:
The old model (MC-TTA1) is not available.

Example: MC-NP21SA1

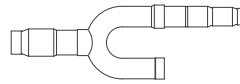

Branch Pipe for Gas Line

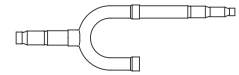

Branch Pipe for Liquid Line

Example: MC-NP31SA

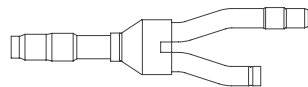

Gas Side

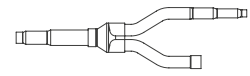

Liquid Side

MULTI-KIT

Branching for indoor and outdoor connecting pipes

Line branch

First branching pipes

Model	ODU HP class
MW-NP282A3	8-10
MW-NP452A3	12-16
MW-NP692A3	18-24
MW-NP902A3	26-54
MW-NP2682A3	56-96

Example: MW-NP282A3

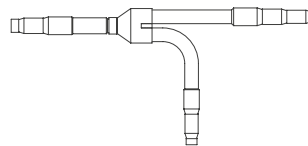

Gas Side

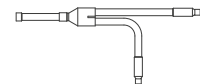

Liquid Side

Pipe diameter after the first branch and multi-kit

Model	Total IDU HP class	Diameter (mm)	
		Gas Pipe	Liquid Pipe
MW-NP282A3	< 6	Φ15.88	Φ9.52
	6-8.99	Φ19.05	Φ9.52
	9-11.99	Φ22.2	Φ9.52
MW-NP452A3	12-15.99	Φ25.4	Φ12.7
	16-17.99	Φ28.58	Φ12.7
MW-NP692A3	18-25.99	Φ28.58	Φ15.88
MW-NP902A3	26-35.99	Φ31.75	Φ19.05
	36-55.99	Φ38.1	Φ19.05
MW-NP2682A3	56-67.99	Φ44.45	Φ19.05
	68-73.99	Φ44.45	Φ22.2
	74-89.99	Φ50.8	Φ22.2
	≥ 90	Φ50.8	Φ25.4

Header branch

Model	Total IDU HP class	No. of Header Branches
MH-NP224A	5-8	4
MH-NP288A	5-10	8

Example: MH-NP224A

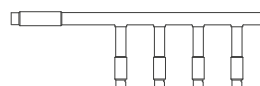

Gas Side

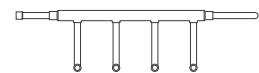

Liquid Side

DRAIN BOSS

The drain boss is for the drain pipe connection in order to use the bottom base of the outdoor unit as a drain pan.

Quantity

Model	Applicable ODU HP class		Q'ty
	FSNP series	FSNS series	
DBS-TP10A	5-14	8-18	1
	16-24	20-36	2
	26-32	38, 40	3
	34, 36	42-48	4
	38-42	50-54	3
	44, 46	56-60	4
	48, 50	62-66	5
	52, 54	68-72	6
	56, 58	74-78	5
	60	80-84	6
	62	86-90	7
	64-72	92-96	8

DBS-TP10A

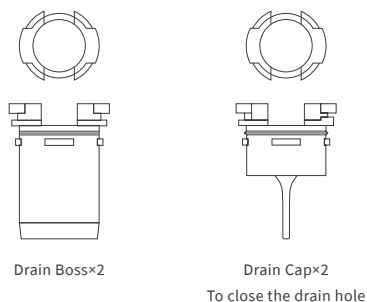

CABINET COVER

Protection net

HP class (kW)		Rear	Right	Left
FSNP series	FSNS series			
5-6(14.0-16.0)	8-12(22.4-33.5)	PN-TP20BA	PN-TP20R	PN-TP20L
8-14(22.4-40.0)	14-18(40.0-50.0)	PN-TP20BB	PN-TP20R	PN-TP20R
16-18(45.0-50.0)	20-24(56.0-67.0)	PN-TP20BC	PN-TP20R	PN-TP20R

Image

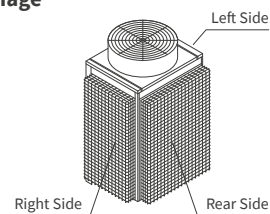

AIR SOURCE HEAT RECOVERY TYPE

LINE UP

High efficiency model: FSXNP series
Space saving model: FSXNS series

Single Module
up to 18HP class (FSXNP)
up to 24HP class (FSXNS)



Two Modules Combination
up to 36HP class (FSXNP)
up to 48HP class (FSXNS)



Whole Range
up to 54HP class (FSXNP/FSXNS)



SUMMARY TABLE

Item	Unit	High efficiency model: FSXNP series	Space saving model: FSXNS series
Capacity	HP class	5-54	8-54
Nominal cooling capacity	kW	14.0-150.0	22.4-150.0
Nominal heating capacity	kW	16.0-165.0	25.0-165.0
Maximum connectable indoor unit quantity		64	64
Combination capacity ratio between ODU and IDU	%	50-150	50-130
Total piping length	m	1,000	1,000
Maximum piping length between ODU and IDU	m	165	165
Maximum equivalent piping length between ODU and IDU	m	190	190
Maximum piping length between 1st branch and IDU	m	90	90
Maximum height difference between ODU and IDU * (when ODU is higher than IDU)	m	110	110
Maximum height difference between ODU and IDU * (when IDU is higher than ODU)	m	110	110
Maximum height difference between IDU and IDU	m	15	15
Cooling Operation Range **	°C DB	-5.0 to 52.0	-5.0 to 48.0
Heating Operation Range **	°C WB	-20.0 to 15.0	-20.0 to 15.0
Simultaneous cooling and heating operation range ***	°C	-5.0 to 24.0°C DB -6.0 to 15.0°C WB	-5.0 to 24.0°C DB -6.0 to 15.0°C WB

* In case the outdoor unit is higher than the indoor units, the standard level difference between outdoor and indoor units is 50m. 110m height difference is possible with a dip switch setting on the outdoor unit (contact Temperzone for details). If the indoor units are higher than the outdoor units, then the standard level difference is 40m. 110m level difference is possible by special order on the factory

** For more details, please consult your distributors or dealer, or, refer to technical manuals.

*** Upper: mainly cooling / Lower: mainly heating for more details, please consult your distributors or dealer, or, refer to technical manuals.

HIGH EFFICIENCY

EFFICIENCY RATIO

High efficiency model: FSXNP series

Cooling EER

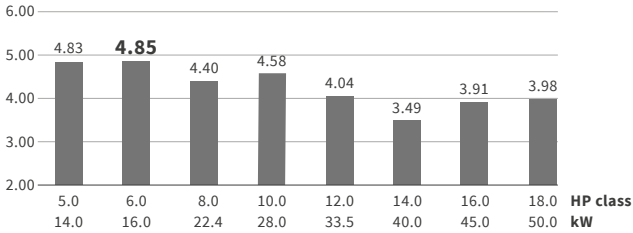

Heating COP

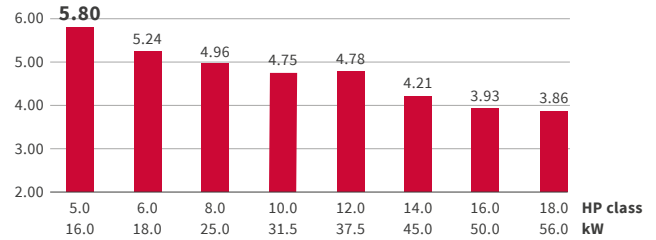

NOTES:

1. The graphs above show the EER/COP of single units for Oceania.
2. The above values indicate the EER/COP per outdoor unit when it is combined with specified indoor units.
3. The specification of EER/COP of each country is different according to the regulation. Please contact your sales person for more information.

Space saving model: FSXNS series

Cooling EER

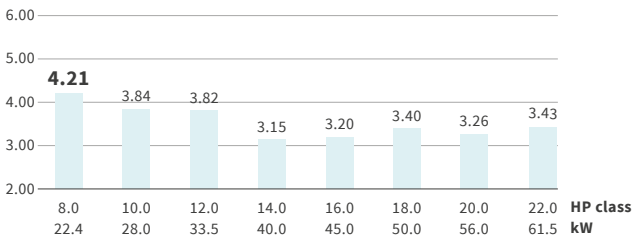

Heating COP

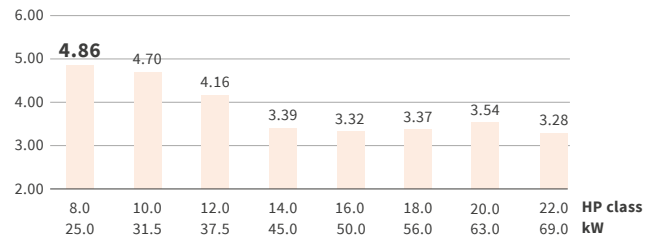

NOTES:

1. The graphs above show the EER/COP of single units for Oceania.
2. The above values indicate the EER/COP per outdoor unit when it is combined with specified indoor units.
3. The specification of EER/COP of each country is different according to the regulation. Please contact your sales person for more information.



WHAT IS HEAT RECOVERY?

SIMULTANEOUS COOLING AND HEATING

The Heat Recovery range is ideal for highly insulated buildings in mild climates that vary by season.

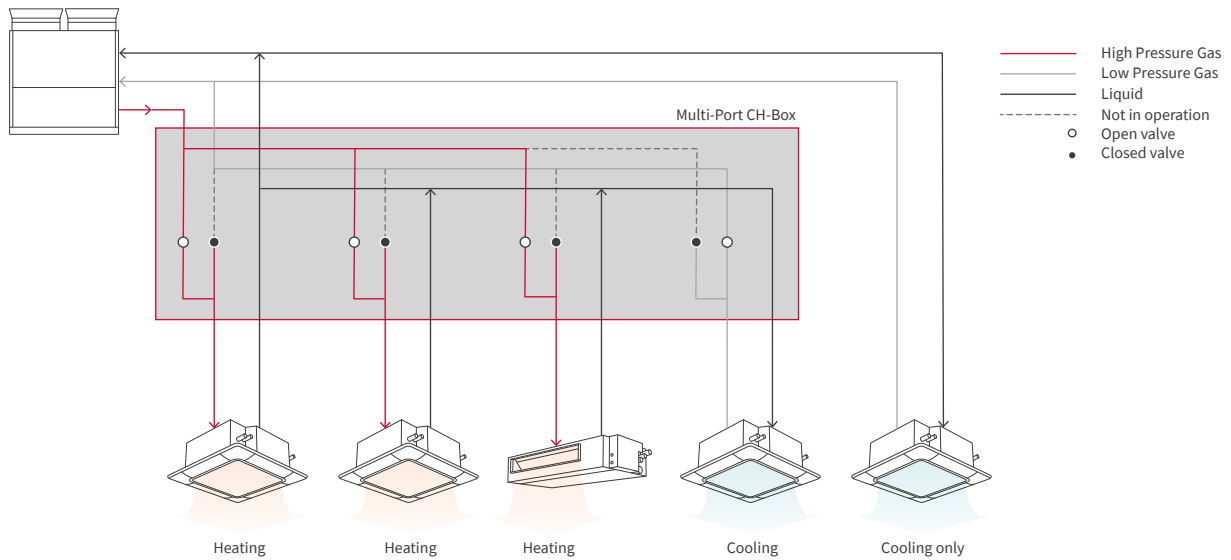

Ex: Heat Recovery 3-pipe system configuration, with Multi-Port CH-Box (mainly heating mode)

Heat Recovery VRF systems are three-pipe systems that transfer any excess energy from one zone to another to deliver simultaneous cooling and heating. Like other VRF systems, they are compatible with all types of indoor units*, including ducted.

*Except fresh air units



Limit your total cooling and heating costs

By using and transferring excess energy from one zone to another, Heat Recovery systems minimise compressor operation to provide simultaneous cooling and heating. This means energy consumption is greatly optimised leading to low energy costs in the mid-season.

In applications where rooms require cooling only all year long, heat recovery - by installing a cooling only indoor unit without CH-Box - can cover this need, thus sparing the need to install an extra dedicated cooling device.

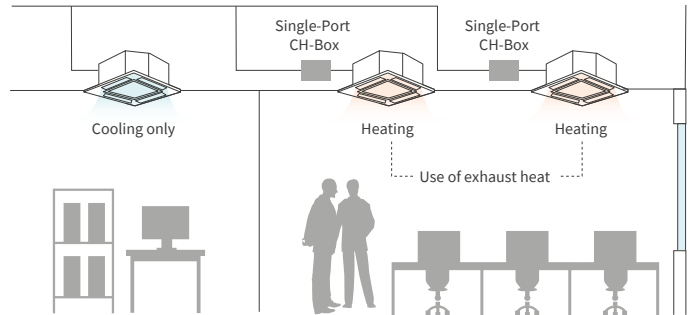

SET FREE Σ

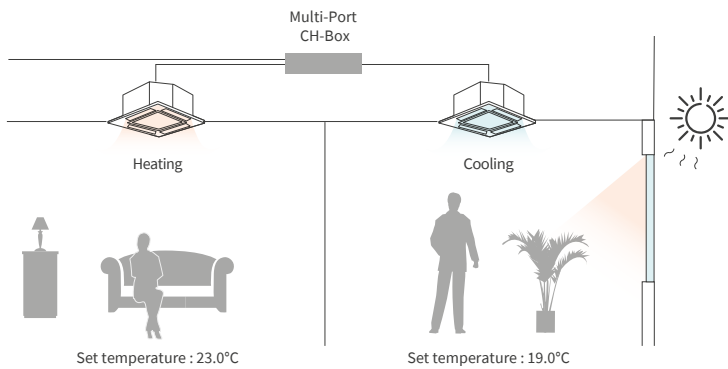

Customised comfort

Thermal needs vary in each room of a building—some people might feel a little too warm, and some a bit chilly. This depends on the individuals, and also on the room’s sunlight exposure and equipment functions. With heat recovery, every occupant can benefit from either cooling or heating at any time, based on his/her preferred set temperature.

WHAT IS HEAT RECOVERY?

Consistent temperature in large zones

The SET FREE Σ Heat Recovery range allows simultaneous cooling and heating, even inside the same zone of the same refrigerant system. It is particularly ideal in large zones where some areas are subject to specific conditions (such as near a sunny window). Thanks to the automatic changeover function, each indoor unit automatically switches from cooling to heating to evenly reach the set temperature.

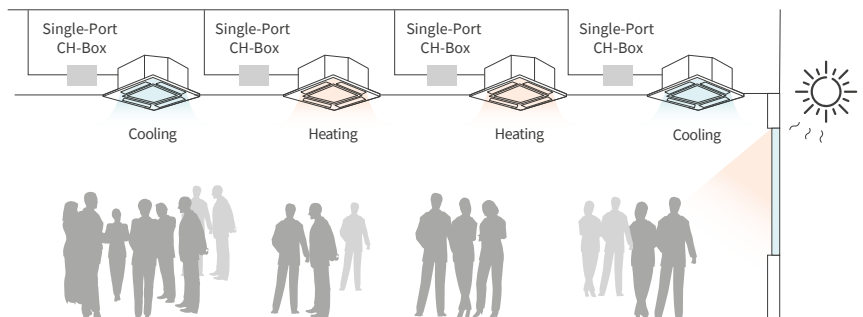

Heat Recovery or Heat Pump?

All buildings do not require simultaneous heating or cooling, such as those in areas with clearly defined seasons or with large, open-plan areas. Temperzone can help you select the system best suited to your building.

DESIGN FLEXIBILITY

NEW CH-BOX (CHANGE-OVER BOX)

Hitachi's CH-Box merit



Top-in-class compact body
Top-in-class light-weight unit

More Design Flexibility



No drain connection needed

Easier Installation

Wider line up

Type	Single-Port		Multi-Port					
	Model	CH-AP160SSX	CH-AP280SSX	CH-AP04MSSX	CH-AP08MSSX	CH-AP12MSSX	CH-AP16MSSX	
Dimensions (H×W×D)	mm	191×301×214	191×301×214	260×303×352	260×543×352	260×783×352	260×1,023×352	
N/W	kg	6	6	14	25	36	47	
Electrical Details	Power Supply	1~/N, [220-240V/50Hz]		1~/N, [220-240V/50Hz]				
	Power Input	W	5	5	11.2	22.4	33.6	44.8
	Current	A	0.1	0.1	0.2	0.4	0.6	0.8
Maximum Total Capacity Index	kW	16	28	44.8	85	85	85	
Number of port (for IDU)		1	1	4	8	12	16	
Maximum Connectable IDUs per Port		7	8	6	6	6	6	
Maximum Piping length	Total piping length between CH-Box and each indoor unit per branch	m	40	40	40	40	40	
	between CH-Box	m	15	15	15	15	15	
Maximum Height difference	Between CH-Box and IDU	m	15	15	15	15	15	
	between IDUs connecting to same CH-Box	m	4	4	4	4	4	

System configuration

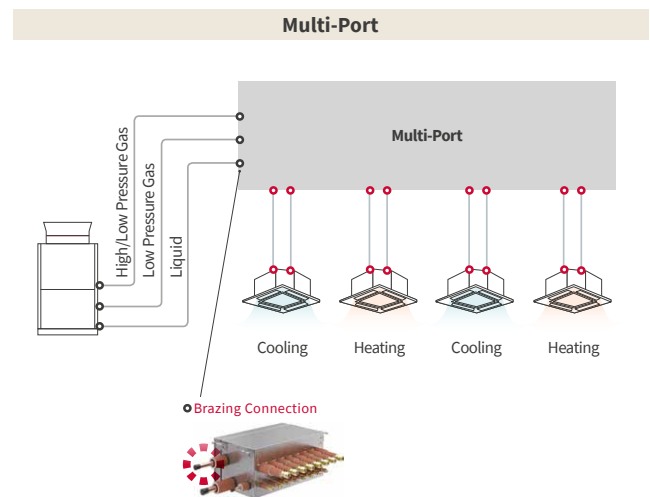
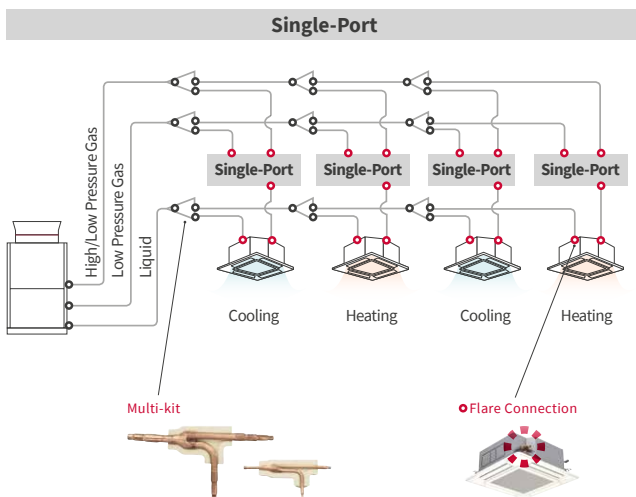



Which is better?

► “Long narrow building” application

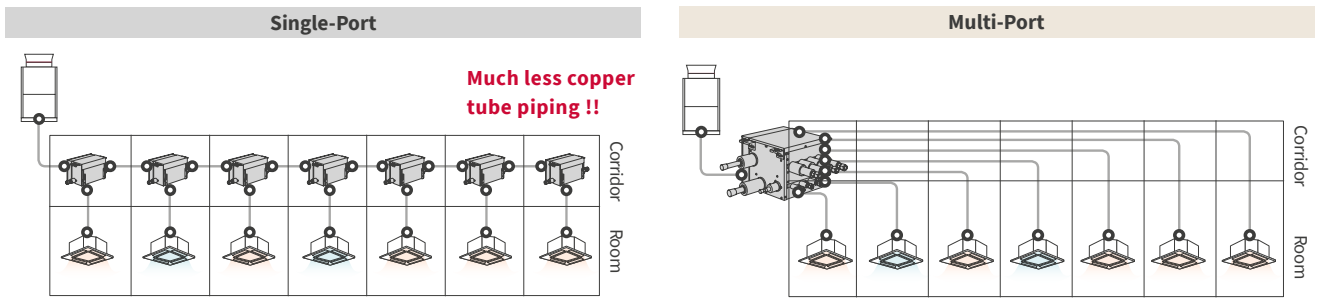

Single-Port	Item	Multi-port
58m	Total piping Length	136m
6	Needed multi-kit sets	0
92 points (Brazing: 57/Flare: 32)	Connection Points	34 points (Brazing: 6/Flare: 28)
14	Hanging Rods for CH-Box	4
14 pieces	Total Ceiling Access Panel	8 pieces

► “Central CH-Box location” application

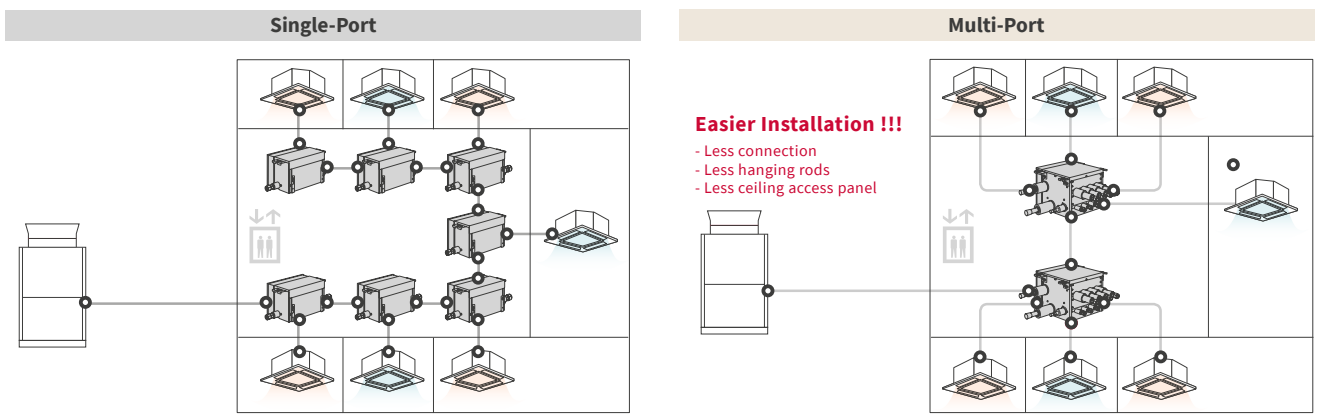

Single-Port	Item	Multi-Port
60m	Total piping Length	63m
6	Needed multi-kit sets	1
92 points (Brazing: 57/Flare: 32)	Connection Points	40 points (Brazing: 12/Flare: 28)
14	Hanging Rods for CH-Box	8
14 locations	Total Ceiling Access Panel	9 locations

DESIGN FLEXIBILITY

MORE FLEXIBLE PIPING

Offering considerable flexibility in piping configurations

Maximum Piping Length

	Example	Length (m)
Total piping length	-	1,000
Refrigerant piping length	L1	165 (190)
Between Piping connection kit and each ODU	La, Lb, Lc	10
Between "1st branch Multi-kit" and the farthest IDU	L2	90
Between "Multi-kit" and each IDU	L3	40
Total piping length Between CH-Box and IDU	-	40

Maximum Height Difference

	Example	Height (m)
Between ODUs (combination of base units)	H1	0.1
Between ODUs and IDUs	ODU above IDU	Standard: 50 Optional: 110
	IDU above ODU	Standard: 40 Optional: 110
Between IDUs	H3	15
Between CH-Box	H4	15
Between IDUs connecting to one CH-Box	H5	4
Between IDU and CH-Box	H6	≤15

Notes:

If ODU is located in above and height difference is more than 50 metres, Please contact Temperzone since special setting is needed.

If ODU is located in lower and height difference is more than 40 metres, Please contact with distributor since this is custom order and special modification is needed.

Other conditions such as working temperature ranges, Please check the details with Temperzone.

Please check the details with Temperzone.

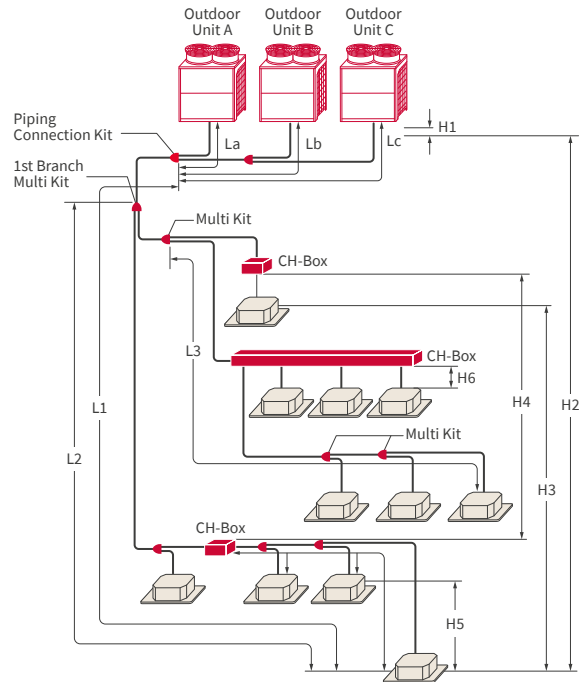

WIDER EXTERNAL STATIC PRESSURE

Designed to be located internally and can operate under 4 ESP settings, up to 80Pa, with multiple options for improved energy savings

Shorter required piping lengths provide greater design flexibility and may also reduce installation costs

New Model 4 Options available

0Pa 30Pa 60Pa 80Pa

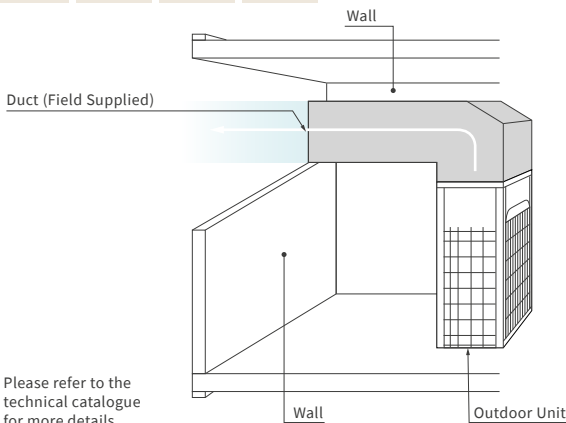

* Please refer to the technical catalogue for more details.

AMBIENT OPERATING TEMPERATURES

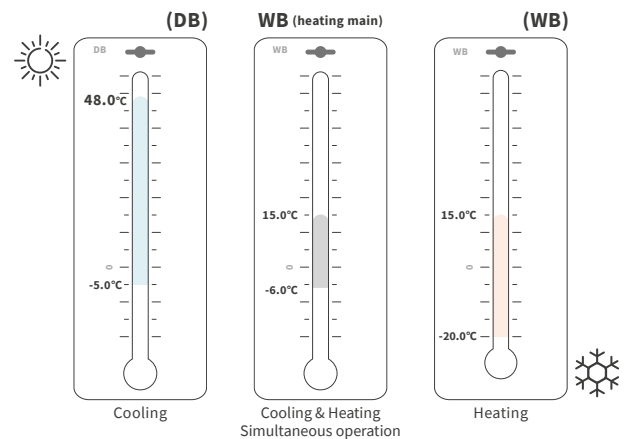

NOTES:

- Cooling operation at maximum 48.0°C DB should be available only if the outdoor air inlet temperature increase temporarily according to the installation condition.
- The cooling capacity is reduced at high ambient temperature. Consider selecting a larger capacity outdoor unit than compatible building heat load.
- The appropriate amount (100%) of refrigerant must be charged. Excessive charging of refrigerant is not permitted.
- Avoid installing the units where affected by direct sunlight reflection and short circuit. There may be the possibility to activate protection control and alarm system if install the units to inappropriate place. Also the life time of the products and parts must be shortened.
- Periodic maintenance (1/certain month) must be applied to the heat exchanger fin to avoid adhesion of dirt and clogging of sand to the outdoor unit heat exchanger.
- Refer to the technical catalog for the detail.
- Operation temperature range in simultaneous heating & cooling varies depending on whether mainly heating or mainly cooling. Refer to technical catalogue for more detail.

DEDICATED TO HIGH PERFORMANCE AND RELIABILITY

Hitachi's G1TOWER was completed in 2010. One of the world's highest elevator research towers, it's the setting for tests on high-performance, reliable elevators that fit the needs of increasingly high-rise, large-scale buildings inside and outside of Japan.

We also use this tower to test our actual products in line with these trends to evaluate their performance and reliability.

Supported by
 Name: G1TOWER
 Address: 1070 Ichige, Hitachinaka-shi, Ibaraki Prefecture(in Mito Works)
 Land area: 388m²
 Building size: 213.5m above ground, 15m below ground
 Floors: Nine above ground, one below ground
 Owner: Building Systems Business Unit; Hitachi, Ltd.
http://www.hitachi.com/businesses/elevator/about_us/g1tower/

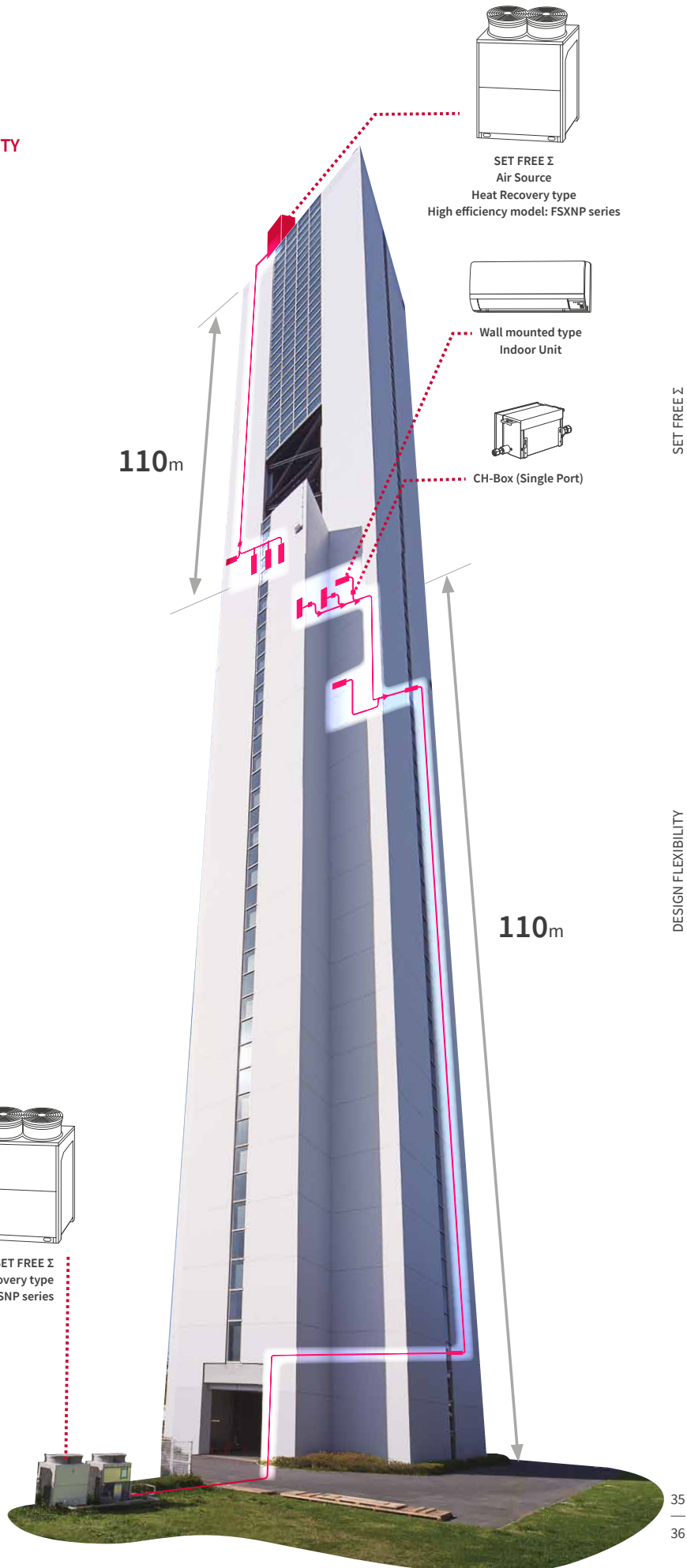

SET FREE Σ
 Air Source
 Heat Recovery type
 High efficiency model: FSXNP series

Wall mounted type
 Indoor Unit

CH-Box (Single Port)

SET FREE Σ
 Air Source Heat Recovery type
 High efficiency model: FSNP series

SET FREE Σ

DESIGN FLEXIBILITY

ADAPTABILITY

AUTO CHANGEOVER SUPERIOR DEFROSTING PERFORMANCE

Consistency is the key to a harmonious interior environment. To ensure a consistent interior climate SET FREE Σ can switch automatically from cooling to heating in any zone, by harvesting the waste heat from other zones.

- Optimised heat recovery ensures greater energy savings
- Indoor unit thermostat or individual remote control can be used for temperature sensing

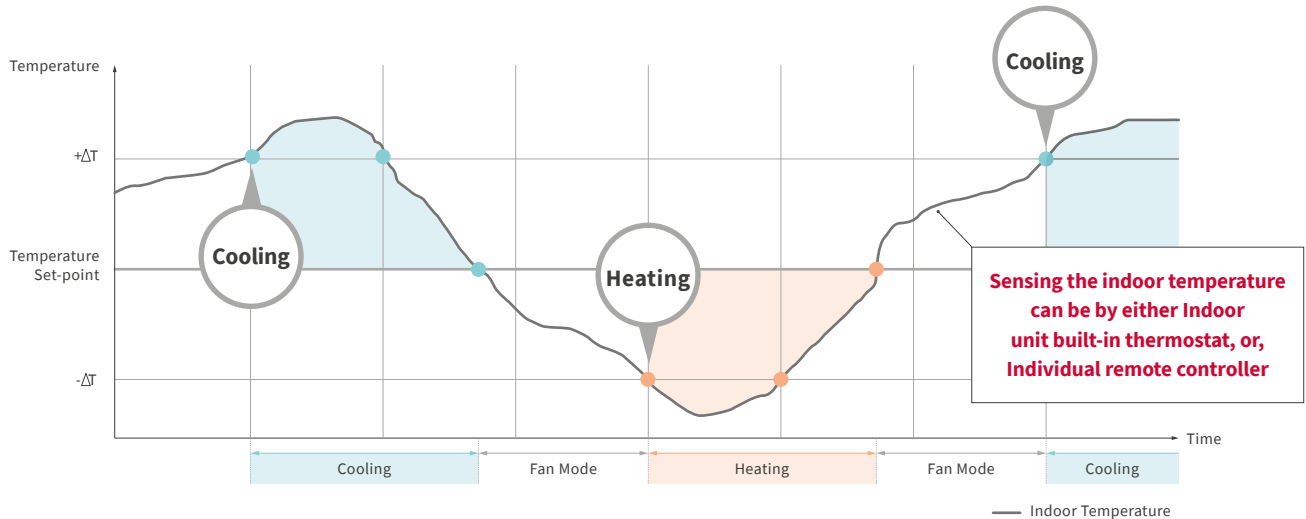

ROTATIONAL OPERATION

To improve unit endurance, standardised running time evenly distributes the load by rotating the order of compressor operation

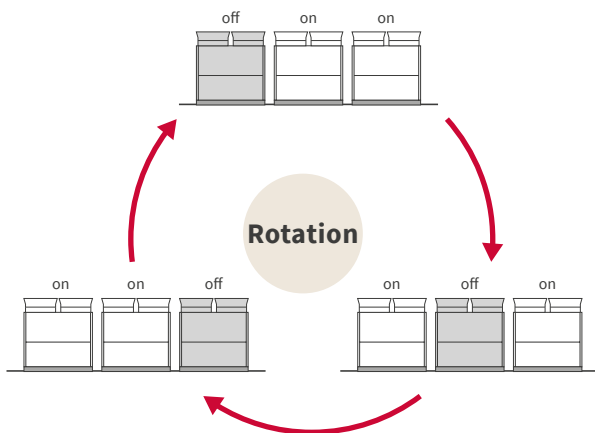

SYSTEM FAILURE PREVENTION

In case of a combination unit

- The Backup Operation Function prevents the system from coming to a complete stop when outdoor unit failure occurs
- If one outdoor unit should fail, the system can continue to operate using the remaining outdoor units
- An alarm is triggered and emergency operation can be activated via an individual remote control
- At least 2 outdoor units (as combined unit) are required for this function
- Emergency operation can be performed within 8 hours after unit stoppage

Combined ODU

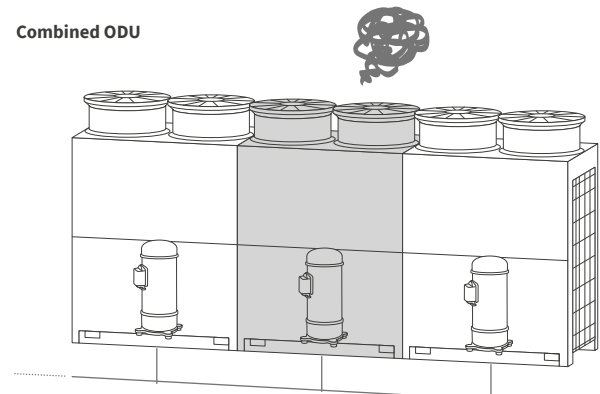

CORROSION RESISTANCE

Corrosion-resistance improved Heat Exchanger

3 Coating Layers

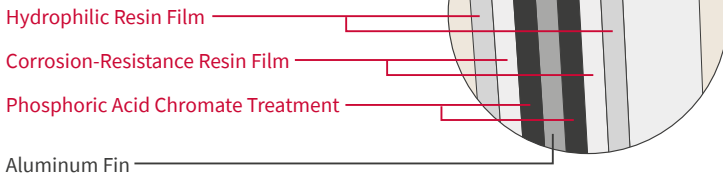

*Considered JRA9002: Criteria and Testing of Corrosion-proof for Refrigeration and Air Conditioning Equipment against Salty Air
 *Please consult Hitachi distributors for more details
 *Both "Anti-corrosive treatment" and "Heavy anti-corrosive treatment" are by custom order

(illustration purpose)
 Life-expectancy comparison
 In salty-air-location

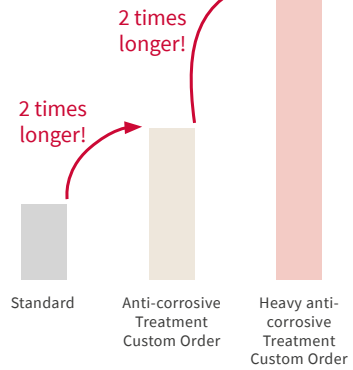

EASE OF MAINTENANCE

With a 7-segment display, revised upper and lower panels and convenient access to compressors and valves, SET FREE Σ outdoor units are easier to access, manage and maintain.

Total structure change

New Structure:

In upper section, all PCB visible and easily accessible

Newly adopted window for 7-segment display:

Adopting access door to the electrical box in the upper panel, which leads to easy access to 7-segment display, PSW & DSW and so on.



New Panel:

The upper panel (on the side of an electric box) can be independently detached from the lower panel (on the compressor chamber side)

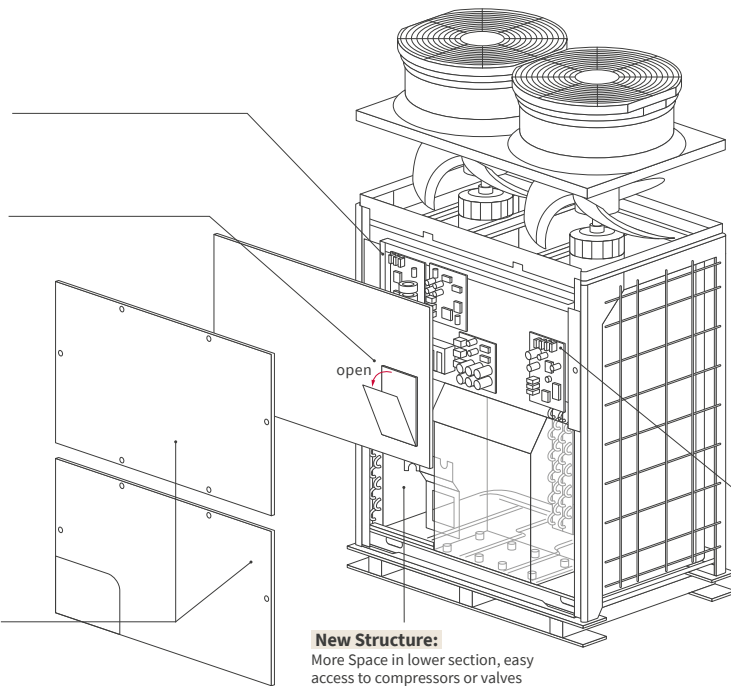

New DSW setting for Refrigerant evacuation:

Enforced operation to open ODU EVO/EVB, IDU EVI, and Hi/Low pressure Bi-pass SVA

After DSW4-4 On

PSW4 () for 3 seconds

fully opening the expansion valves of outdoor unit (EVO, EVB) and the expansion valve of indoor unit (EVI), and opening the solenoid valve of outdoor unit (SVA)

Simplify "refrigerant recovery & evacuation work" and "air tight test" during servicing

Mechanical Contractor & Installer

SPECIFICATIONS

High efficiency model: FSXNP series



HP class

Model

		5	6	8	10	12	14		
		RAS-5FSXNP	RAS-6FSXNP	RAS-8FSXNP	RAS-10FSXNP	RAS-12FSXNP	RAS-14FSXNP		
Power Supply		AC 3φ, [400V/50Hz] [380-415V/50Hz] [380V/60Hz] [220V/60Hz]							
Nominal Cooling Capacity		kW	14.0	16.0	22.4	28.0	33.5	40.0	
Nominal Heating Capacity		kW	16.0	18.0	25.0	31.5	37.5	45.0	
Cabinet	Colour	Natural Gray (1.0Y 8.5/0.5)							
	Munsell Code								
Outer Dimensions	H×W×D	mm	1,675×950×765	1,675×950×765	1,675×1,210×765	1,675×1,210×765	1,675×1,210×765	1,675×1,210×765	
	Sound Power Level	dB(A)	75	78	77	82	83	85	
Sound Level	Sound Pressure Level	dB(A)	54	56	55	59	60	62	
	Net Weight	kg	195	195	258	262	263	273	
Weight	Gross Weight	kg	211	211	276	280	281	291	
	Net Weight	kg	190	190	253	257	258	268	
	Gross Weight	kg	211	211	276	280	281	291	
	Gross Weight	kg	206	206	271	275	276	286	
Refrigerant	Type	R410A							
	Flow Control	Micro-Computer Control Expansion Valve							
	Charge (before Shipment)	kg	4.7	5.0	8.5	8.5	9.3	9.3	
Compressor	Type	Hermetic (Scroll)							
	Model	AA50PHD	AA50PHD	AA50PHD	DB65PHD	DC80PHD	DC80PHD		
	Quantity	1	1	1	1	1	1		
	Motor Output (Pole)	kW	1.9(6)	2.1(6)	3.1(6)	3.8(6)	5.1(6)	6.4(6)	
Refrigeration Oil	Type	FVC68D							
	Charge	L/Unit	6.0	6.0	6.0	6.0	6.0	6.9	
Heat Exchanger		Multi-Pass Cross-Finned Tube							
Condenser Fan	Type	Propeller Fan							
	Quantity	1	1	2	2	2	2		
	Air Flow Rate	m³/min.	150	170	185	219	219	243	
	Motor Output (Pole)	kW	0.20(8)	0.28(8)	0.18(8)×2	0.26(8)×2	0.26(8)×2	0.34(8)×2	
Main Refrigerant Piping	Liquid Line	mm	φ9.52	φ9.52	φ9.52	φ9.52	φ12.7	φ12.7	
Heat Recovery System (3 Pipes)	Gas Line	Low Pressure	mm	φ15.88	φ19.05	φ19.05	φ22.2	φ25.4	φ25.4
		High/Low Pressure	mm	φ12.7	φ15.88	φ15.88	φ19.05	φ22.2	φ22.2
Package	Dimensions	H×W×D	mm	1,800×1,030×810	1,800×1,030×810	1,800×1,290×810	1,800×1,290×810	1,800×1,290×810	1,800×1,290×810
	Measurement	m³	1.5	1.5	1.9	1.9	1.9	1.9	

Notes:

- The cooling and heating performances are the values when combined with our specified indoor units.
 Cooling Operation Conditions
 Indoor Air Inlet Temperature: 27.0°C DB
 19.0°C WB
 Outdoor Air Inlet Temperature: 35°C DB
 Piping Length: 7.5 metres
 Piping Lift: 0 metres
 Heating Operation Conditions
 Indoor Air Inlet Temperature: 20.0°C DB
 Outdoor Air Inlet Temperature: 7.0°C DB
 6.0°C WB
 Piping Length: 7.5 metres
 Piping Lift: 0 metres
- The sound pressure is based on the following conditions.
 The above data is based on the cooling mode. In case of heating mode, the sound pressure level increases by approximately 1~2 dB.
 The above data was measured in an anechoic chamber so that reflected sound should be taken into consideration in the field.
- The width of outer dimension, it is the value when each distance between the base outdoor units is specified to 20mm.



HP class

Model

			16	18	20	22	24	
			RAS-16FSXNP	RAS-18FSXNP	RAS-20FSXNP	RAS-22FSXNP	RAS-24FSXNP	
Combination of Base Unit			-	-	RAS-10FSXNP RAS-10FSXNP	RAS-10FSXNP RAS-12FSXNP	RAS-12FSXNP RAS-12FSXNP	
Power Supply			AC 3φ, [400V/50Hz] [380-415V/50Hz] [380V/60Hz] [220V/60Hz]					
Nominal Cooling Capacity	kW		45.0	50.0	56.0	61.5	67.0	
Nominal Heating Capacity	kW		50.0	56.0	63.0	69.0	77.5	
Cabinet	Colour	Munsell Code	Natural Gray (1.0Y 8.5/0.5)					
	Outer Dimensions	H×W×D	mm	1,675×1,600×765	1,675×1,600×765	1,675×2,440×765	1,675×2,440×765	1,675×2,440×765
Sound Level	Sound Power Level		dB(A)	85	86	85	86	86
	Sound Pressure Level		dB(A)	65	65	62	62.5	63
Weight	Net Weight	400V/50Hz	kg	350	365	262+262	262+263	263+263
		380-415V/50Hz	kg					
	380V/60Hz	kg						
	220V/60Hz	kg	345	360	257+257	257+258	258+258	
Gross Weight	400V/50Hz	kg	370	385	280+280	280+281	281+281	
	380-415V/50Hz	kg						
380V/60Hz	kg							
220V/60Hz	kg	365	380	275+275	275+276	276+276		
Refrigerant	Type		R410A					
	Flow Control		Micro-Computer Control Expansion Valve					
	Charge (before Shipment)	kg	10.0	10.6	17.0	17.8	18.6	
Compressor	Type		Hermetic (Scroll)					
	Model		AA50PHD+AA50PHD	DC80PHD+DC80PHD	DB65PHD+DB65PHD	DB65PHD+DC80PHD	DC80PHD+DC80PHD	
	Quantity		2	2	2	2	2	
	Motor Output (Pole)	kW	3.7(6)×2	4.4(6)×2	3.8(6)×2	3.8(6)×1+5.1(6)×1	5.1(6)×2	
Refrigeration Oil	Type		FVC68D					
	Charge	L/Unit	7.9	7.9	12.0	12.0	12.0	
Heat Exchanger			Multi-Pass Cross-Finned Tube					
Condenser Fan	Type		Propeller Fan					
	Quantity		2	2	4	4	4	
	Air Flow Rate	m ³ /min.	326	362	219×2	219×2	219×2	
	Motor Output (Pole)	kW	0.47(8)×2	0.62(8)×2	0.26(8)×+0.26(8)×2	0.26(8)×2+0.26(8)×2	0.26(8)×2+0.26(8)×2	
Main Refrigerant Piping	Liquid Line	mm	φ12.7	φ15.88	φ15.88	φ15.88	φ15.88	
	Gas Line	Low Pressure	mm	φ28.58	φ28.58	φ28.58	φ28.58	φ28.58
High/Low Pressure		mm	φ22.2	φ22.2	φ22.2	φ25.4	φ25.4	
Heat Recovery System (3 Pipes)	Dimensions	H×W×D	mm	1,800×1,680×810	1,800×1,680×810	-	-	-
	Measurement	m ³		2.4	2.4	-	-	-

Notes:

- The cooling and heating performances are the values when combined with our specified indoor units.

Cooling Operation Conditions	Heating Operation Conditions
Indoor Air Inlet Temperature: 27.0°C DB	Indoor Air Inlet Temperature: 20.0°C DB
19.0°C WB	Outdoor Air Inlet Temperature: 7.0°C DB
Outdoor Air Inlet Temperature: 35°C DB	6.0°C WB
Piping Length: 7.5 metres	Piping Length: 7.5 metres
Piping Lift: 0 metres	Piping Lift: 0 metres
- The sound pressure is based on the following conditions.

The above data is based on the cooling mode. In case of heating mode, the sound pressure level increases by approximately 1-2 dB.

The above data was measured in an anechoic chamber so that reflected sound should be taken into consideration in the field.
- The width of outer dimension, it is the value when each distance between the base outdoor units is specified to 20mm.

SPECIFICATIONS

High efficiency model: FSXNP series



HP class

Model

			26	28	30	32	34	36	
			RAS-26FSXNP	RAS-28FSXNP	RAS-30FSXNP	RAS-32FSXNP	RAS-34FSXNP	RAS-36FSXNP	
Combination of Base Unit			RAS-10FSXNP RAS-16FSXNP	RAS-12FSXNP RAS-16FSXNP	RAS-12FSXNP RAS-18FSXNP	RAS-14FSXNP RAS-18FSXNP	RAS-16FSXNP RAS-18FSXNP	RAS-18FSXNP RAS-18FSXNP	
Power Supply			AC 3φ, [400V/50Hz] [380-415V/50Hz] [380V/60Hz] [220V/60Hz]						
Nominal Cooling Capacity			kW	73.0	77.5	85.0	90.0	95.0	100.0
Nominal Heating Capacity			kW	82.5	90.0	95.0	100.0	106.0	112.0
Cabinet	Colour	Munsell Code	Natural Gray (1.0Y 8.5/0.5)						
	Outer Dimensions	H×W×D	mm	1,675×2,830×765	1,675×2,830×765	1,675×2,830×765	1,675×2,830×765	1,675×3,220×765	1,675×3,220×765
Sound Level	Sound Power Level	dB(A)	87	87	88	89	89	89	
	Sound Pressure Level	dB(A)	66	66	66	67	68	68	
Weight	Net Weight	400V/50Hz	kg	262+350	263+350	263+365	273+365	350+365	365+365
		380-415V/50Hz	kg	262+350	263+350	263+365	273+365	350+365	365+365
	380V/60Hz	kg	257+345	258+345	258+360	268+360	345+360	360+360	
	220V/60Hz	kg	257+345	258+345	258+360	268+360	345+360	360+360	
Gross Weight	400V/50Hz	kg	280+370	281+370	281+385	291+385	370+385	385+385	
	380-415V/50Hz	kg	280+370	281+370	281+385	291+385	370+385	385+385	
380V/60Hz	kg	275+365	276+365	276+380	286+380	365+380	380+380		
220V/60Hz	kg	275+365	276+365	276+380	286+380	365+380	380+380		
Refrigerant	Type	R410A							
	Flow Control	Micro-Computer Control Expansion Valve							
	Charge (before Shipment)	kg	18.5	19.3	19.9	19.9	20.6	21.2	
Compressor	Type	Hermetic (Scroll)							
	Model	DB65PHD+AA50PHD +AA50PHD		DC80PHD+AA50PHD +AA50PHD		DC80PHD+DC80PHD +DC80PHD		DC80PHD+DC80PHD +DC80PHD	
	Quantity	3		3		3		4	
	Motor Output (Pole)	kW	3.8(6)×1+3.7(6)×2		5.1(6)×1+3.7(6)×2		5.1(6)×1+4.4(6)×2		6.4(6)×1+4.4(6)×2
Refrigeration Oil	Type	FVC68D							
	Charge	L/Unit	13.9	13.9	13.9	14.8	15.8	15.8	
Heat Exchanger			Multi-Pass Cross-Finned Tube						
Condenser Fan	Type	Propeller Fan							
	Quantity	4							
	Air Flow Rate	m³/min.	219+326	219+326	219+362	243+362	326+362	362×2	
	Motor Output (Pole)	kW	0.26(8)×2 +0.47(8)×2		0.26(8)×2 +0.47(8)×2		0.34(8)×2 +0.62(2)×2		0.47(2)×2 +0.62(2)×2
Main Refrigerant Piping	Liquid Line	mm	φ19.05	φ19.05	φ19.05	φ19.05	φ19.05	φ19.05	
	Gas Line	Low Pressure	mm	φ31.75	φ31.75	φ31.75	φ31.75	φ31.75	φ38.1
High/Low Pressure		mm	φ25.4	φ28.58	φ28.58	φ28.58	φ28.58	φ28.58	

Notes:

- The cooling and heating performances are the values when combined with our specified indoor units.

Cooling Operation Conditions	Indoor Air Inlet Temperature: 27.0°C DB	Heating Operation Conditions	Indoor Air Inlet Temperature: 20.0°C DB
	19.0°C WB		Outdoor Air Inlet Temperature: 7.0°C DB
	Outdoor Air Inlet Temperature: 35°C DB		6.0°C WB

Piping Length: 7.5 metres
Piping Lift: 0 metres
- The sound pressure is based on the following conditions.
 The above data is based on the cooling mode. In case of heating mode, the sound pressure level increases by approximately 1~2 dB.
 The above data was measured in an anechoic chamber so that reflected sound should be taken into consideration in the field.
- Except for the specified combination in the table (26~54HP class 73.0~150.0kW), there is no other combination of the base unit.
- The width of outer dimension, it is the value when each distance between the base outdoor units is specified to 20mm.



HP class

Model

		38	40	42	44	46		
		RAS-38FSXNP	RAS-40FSXNP	RAS-42FSXNP	RAS-44FSXNP	RAS-46FSXNP		
Combination of Base Unit		RAS-12FSXNP RAS-12FSXNP RAS-14FSXNP	RAS-12FSXNP RAS-14FSXNP RAS-14FSXNP	RAS-14FSXNP RAS-14FSXNP RAS-14FSXNP	RAS-12FSXNP RAS-14FSXNP RAS-18FSXNP	RAS-14FSXNP RAS-14FSXNP RAS-18FSXNP		
Power Supply		AC 3φ, [400V/50Hz] [380-415V/50Hz] [380V/60Hz] [220V/60Hz]						
Nominal Cooling Capacity	kW	106.0	112.0	118.0	122.0	128.0		
Nominal Heating Capacity	kW	118.0	125.0	132.0	140.0	145.0		
Cabinet	Colour	Natural Gray (1.0Y 8.5/0.5)						
	Munsell Code							
Outer Dimensions	H×W×D	mm	1,675×3,670×765	1,675×3,670×765	1,675×3,670×765	1,675×4,060×765	1,675×4,060×765	
Sound Level	Sound Power Level	dB(A)	89	89	90	90	90	
	Sound Pressure Level	dB(A)	65.5	66	67	67.5	68	
Weight	Net Weight	400V/50Hz 380-415V/50Hz 380V/60Hz	kg	263+263+273	263+273+273	273+273+273	263+273+365	273+273+365
		220V/60Hz	kg	258+258+268	258+268+268	268+268+268	258+268+360	268+268+360
	Gross Weight	400V/50Hz 380-415V/50Hz 380V/60Hz	kg	281+281+291	281+291+291	291+291+291	281+291+385	291+291+385
220V/60Hz		kg	276+276+286	276+286+286	286+286+286	276+286+380	286+286+380	
Refrigerant	Type		R410A					
	Flow Control		Micro-Computer Control Expansion Valve					
	Charge (before Shipment)	kg	27.9	27.9	27.9	29.2	30.5	
Compressor	Type		Hermetic (Scroll)					
	Model		DC80PHD+DC80PHD +DC80PHD	DC80PHD+DC80PHD +DC80PHD	DC80PHD+DC80PHD +DC80PHD	DC80PHD+DC80PHD +DC80PHD+DC80PHD	DC80PHD+DC80PHD +DC80PHD+DC80PHD	
	Quantity		3	3	3	4	4	
Motor Output (Pole)	kW		5.1(6)×2+6.4(6)×1	5.1(6)×1+6.4(6)×2	6.4(6)×3	5.1(6)×1+6.4(6)×1 +4.4(6)×2	6.4(6)×1+6.4(6)×1 +4.4(6)×2	
Refrigeration Oil	Type		FVC68D					
	Charge	L/Unit	18.9	19.8	20.7	20.8	21.7	
Heat Exchanger			Multi-Pass Cross-Finned Tube					
Condenser Fan	Type		Propeller Fan					
	Quantity		6	6	6	6	6	
	Air Flow Rate	m ³ /min.	219×2+243	219+243×2	243×3	219+243+362	243×2+362	
Motor Output (Pole)	kW		0.26(8)×2+0.26(8)×2 +0.34(8)×2	0.26(8)×2+0.34(8)×2 +0.34(8)×2	0.34(8)×2+0.34(8)×2 +0.34(8)×2	0.26(8)×2+0.34(8)×2 +0.62(8)×2	0.34(8)×2+0.34(8)×2 +0.62(8)×2	
Main Refrigerant Piping	Liquid Line	mm	φ19.05	φ19.05	φ19.05	φ19.05	φ19.05	
Heat Recovery System (3 Pipes)	Gas Line	Low Pressure	mm	φ38.1	φ38.1	φ38.1	φ38.1	φ38.1
		High/Low Pressure	mm	φ31.75	φ31.75	φ31.75	φ31.75	φ31.75

- Notes:
- The cooling and heating performances are the values when combined with our specified indoor units.
 Cooling Operation Conditions: Indoor Air Inlet Temperature: 27.0°C DB, 19.0°C WB
 Heating Operation Conditions: Indoor Air Inlet Temperature: 20.0°C DB, Outdoor Air Inlet Temperature: 7.0°C DB, 6.0°C WB
 Outdoor Air Inlet Temperature: 35°C DB
 Piping Length: 7.5 metres
 Piping Lift: 0 metres
 - The sound pressure is based on the following conditions.
 The above data is based on the cooling mode. In case of heating mode, the sound pressure level increases by approximately 1~2 dB.
 The above data was measured in an anechoic chamber so that reflected sound should be taken into consideration in the field.
 - Except for the specified combination in the table (26~54HP class 73.0~150.0kW), there is no other combination of the base unit.
 - The width of outer dimension, it is the value when each distance between the base outdoor units is specified to 20mm.

SPECIFICATIONS

High efficiency model: FSXNP series



HP class

48

50

52

54

Model

RAS-48FSXNP

RAS-50FSXNP

RAS-52FSXNP

RAS-54FSXNP

Combination of Base Unit			RAS-12FSXNP RAS-18FSXNP RAS-18FSXNP	RAS-14FSXNP RAS-18FSXNP RAS-18FSXNP	RAS-16FSXNP RAS-18FSXNP RAS-18FSXNP	RAS-18FSXNP RAS-18FSXNP RAS-18FSXNP	
Power Supply			AC 3φ, [400V/50Hz] [380-415V/50Hz] [380V/60Hz] [220V/60Hz]				
Nominal Cooling Capacity		kW	136.0	140.0	145.0	150.0	
Nominal Heating Capacity		kW	150.0	155.0	160.0	165.0	
Cabinet	Colour	Munsell Code	Natural Gray (1.0Y 8.5/0.5)				
	Outer Dimensions	H×W×D	mm	1,675×4,450×765	1,675×4,450×765	1,675×4,840×765	1,675×4,840×765
Sound Level	Sound Power Level		dB(A)	90	90	90	91
	Sound Pressure Level		dB(A)	68.5	69	70	70
Weight	Net Weight	400V/50Hz 380-415V/50Hz 380V/60Hz	kg	263+365+365	273+365+365	350+365+365	365+365+365
		220V/60Hz	kg	258+360+360	268+360+360	345+360+360	360+360+360
	Gross Weight	400V/50Hz 380-415V/50Hz 380V/60Hz	kg	281+385+385	291+385+385	370+385+385	385+385+385
220V/60Hz		kg	276+380+380	286+380+380	365+380+380	380+380+380	
Refrigerant	Type		R410A				
	Flow Control		Micro-Computer Control Expansion Valve				
	Charge (before Shipment)	kg	30.5	30.5	31.2	31.8	
Compressor	Type		Hermetic (Scroll)				
	Model		DC80PHD+DC80PHD +DC80PHD+DC80PHD +DC80PHD				
	Quantity		5				
	Motor Output (Pole)		kW	5.1(6)×1+4.4(6)×2+4.4(6)×2	6.4(6)×1+4.4(6)×2+4.4(6)×2	3.7(6)×2+4.4(6)×2+4.4(6)×2	4.4(6)×2+4.4(6)×2+4.4(6)×2
Refrigeration Oil	Type		FVC68D				
	Charge	L/Unit	21.8	22.7	23.7	23.7	
Heat Exchanger		Multi-Pass Cross-Finned Tube					
Condenser Fan	Type		Propeller Fan				
	Quantity		6				
	Air Flow Rate		m³/min.	219+362×2	243+362×2	326+362×2	362×3
	Motor Output (Pole)		kW	0.26(8)×2+0.62(8)×2 +0.62(8)×2	0.34(8)×2+0.62(8)×2 +0.62(8)×2	0.47(8)×2+0.62(8)×2 +0.62(8)×2	0.62(8)×2+0.62(8)×2 +0.62(8)×2
Main Refrigerant Piping	Liquid Line	mm	φ19.05	φ19.05	φ19.05	φ19.05	
Heat Recovery System (3 Pipes)	Gas Line	Low Pressure	mm	φ38.1	φ38.1	φ38.1	φ38.1
		High/Low Pressure	mm	φ31.75	φ31.75	φ31.75	φ31.75

Notes:

- The cooling and heating performances are the values when combined with our specified indoor units.
Cooling Operation Conditions
Indoor Air Inlet Temperature: 27.0°C DB
19.0°C WB
Outdoor Air Inlet Temperature: 35°C DB
Piping Length: 7.5 metres
Piping Lift: 0 metres
Heating Operation Conditions
Indoor Air Inlet Temperature: 20.0°C DB
Outdoor Air Inlet Temperature: 7.0°C DB
6.0°C WB
Piping Length: 7.5 metres
Piping Lift: 0 metres
- The sound pressure is based on the following conditions.
The above data is based on the cooling mode. In case of heating mode, the sound pressure level increases by approximately 1~2 dB.
The above data was measured in an anechoic chamber so that reflected sound should be taken into consideration in the field.
- Except for the specified combination in the table (26~54HP class 73.0~150.0kW), there is no other combination of the base unit.
- The width of outer dimension, it is the value when each distance between the base outdoor units is specified to 20mm.

SPECIFICATIONS

Space saving model: FSXNS series



HP class

8 10 12 14 16 18

Model

RAS-8FSXNS **RAS-10FSXNS** **RAS-12FSXNS** **RAS-14FSXNS** **RAS-16FSXNS** **RAS-18FSXNS**

Power Supply				AC 3φ, [400V/50Hz] [380-415V/50Hz] [380V/60H] [220V/60Hz]						
Nominal Cooling Capacity				kW	22.4	28.0	33.5	40.0	45.0	50.0
Nominal Heating Capacity				kW	25.0	31.5	37.5	45.0	50.0	56.0
Cabinet	Colour	Munsell Code		Natural Gray (1.0Y 8.5/0.5)						
	Outer Dimensions	H×W×D	mm	1,675×950×765	1,675×950×765	1,675×950×765	1,675×1,210×765	1,675×1,210×765	1,675×1,210×765	
Sound Level	Sound Power Level			dB(A)	80	82	82	85	85	86
	Sound Pressure Level			dB(A)	58	60	59	63	63	65
Weight	Net Weight	400V/50Hz		kg	195	195	215	271	314	315
		380-415V/50Hz		kg						
	380V/60Hz		kg	190	190	210	266	309	310	
	220V/60Hz		kg	190	190	210	266	309	310	
Refrigerant	Gross Weight	400V/50Hz		kg	211	211	231	289	332	333
		380-415V/50Hz		kg						
	380V/60Hz		kg	206	206	226	284	327	328	
	220V/60Hz		kg	206	206	226	284	327	328	
Refrigerant	Type			R410A						
	Flow Control			Micro-Computer Control Expansion Valve						
	Charge (before Shipment)			kg	5.0	5.0	7.2	8.9	9.9	10.7
Compressor	Type			Hermetic (Scroll)						
	Model			AA50PHD	AA50PHD	DC80PHD	DC80PHD	AA50PHD +AA50PHD	AA50PHD +AA50PHD	
	Quantity			1	1	1	1	2	2	
Refrigeration Oil	Motor Output (Pole)			kW	3.3(6)	4.3(6)	5.4(6)	8.0(6)	4.5(6)×2	5.0(6)×2
	Type			FVC68D						
	Charge			L/Unit	6.0	6.0	6.0	6.9	7.9	7.9
Heat Exchanger				Multi-Pass Cross-Finned Tube						
Condenser Fan	Type			Propeller Fan						
	Quantity			1	1	1	2	2	2	
	Air Flow Rate			m³/min.	165	170	190	239	256	256
	Motor Output (Pole)			kW	0.26(8)	0.28(8)	0.42(8)	0.33(8)×2	0.39(8)×2	0.39(8)×2
Main Refrigerant Piping	Liquid Line			mm	φ9.52	φ9.52	φ12.7	φ12.7	φ12.7	φ15.88
	Heat Recovery System (3 Pipes)	Gas Line	Low Pressure	mm	φ19.05	φ22.2	φ25.4	φ25.4	φ28.58	φ28.58
High/Low Pressure			mm	φ15.88	φ19.05	φ22.2	φ22.2	φ22.2	φ22.2	
Package	Dimensions H×W×D			mm	1,800×1,030×810	1,800×1,030×810	1,800×1,030×810	1,800×1,290×810	1,800×1,290×810	1,800×1,290×810
	Measurement			m³	1.5	1.5	1.5	1.9	1.9	1.9

Notes:

- The cooling and heating performances are the values when combined with our specified indoor units.

Cooling Operation Conditions	Heating Operation Conditions
Indoor Air Inlet Temperature: 27.0°C DB	Indoor Air Inlet Temperature: 20.0°C DB
19.0°C WB	Outdoor Air Inlet Temperature: 7.0°C DB
Outdoor Air Inlet Temperature: 35°C DB	6.0°C WB

Piping Length: 7.5 metres Piping Length: 7.5 metres
Piping Lift: 0 metres Piping Lift: 0 metres
- The sound pressure is based on the following conditions.
The above data is based on the cooling mode. In case of heating mode, the sound pressure level increases by approximately 1~2 dB.
The above data was measured in an anechoic chamber so that reflected sound should be taken into consideration in the field.
- The width of outer dimension, it is the value when each distance between the base outdoor units is specified to 20mm.

SPECIFICATIONS

Space saving model: FSXNS series



HP class				20	22	24	
Model				RAS-20FSXNS	RAS-22FSXNS	RAS-24FSXNS	
Power Supply				AC 3φ, [400V/50Hz] [380-415V/50Hz] [380V/60H] [220V/60Hz]			
Nominal Cooling Capacity				kW	56.0	61.5	67.0
Nominal Heating Capacity				kW	63.0	69.0	77.5
Cabinet	Colour	Munsell Code	Natural Gray (1.0Y 8.5/0.5)				
	Outer Dimensions	H×W×D	mm	1,675×1,600×765	1,675×1,600×765	1,675×1,600×765	
Sound Level	Sound Power Level		dB(A)	86	84	86	
	Sound Pressure Level		dB(A)	65	64	66	
Weight	Net Weight	400V/50Hz	kg	355	369	370	
		380-415V/50Hz	kg	355	369	370	
	380V/60Hz	kg	350	364	365		
	220V/60Hz	kg	350	364	365		
Gross Weight	400V/50Hz	kg	375	389	390		
	380-415V/50Hz	kg	375	389	390		
380V/60Hz	kg	370	384	385			
Refrigerant	Type		R410A				
	Flow Control		Micro-Computer Control Expansion Valve				
	Charge (before Shipment)	kg	11.3	11.3	11.6		
Compressor	Type		Hermetic (Scroll)				
	Model		AA50PHD+AA50PHD	DC80PHD+DC80PHD	DC80PHD+DC80PHD		
	Quantity		2	2	2		
	Motor Output (Pole)	kW	5.5(6)×2	6.7(6)×2	7.1(6)×2		
Refrigeration Oil	Type		FVC68D				
	Charge	L/Unit	8.4	8.4	8.4		
Heat Exchanger				Multi-Pass Cross-Finned Tube			
Condenser Fan	Type		Propeller Fan				
	Quantity		2	2	2		
	Air Flow Rate	m ³ /min.	329	329	348		
	Motor Output (Pole)	kW	0.48(8)×2	0.48(8)×2	0.56(8)×2		
Main Refrigerant Piping	Liquid Line		mm	φ15.88	φ15.88	φ15.88	
Heat Recovery System (3 Pipes)	Gas Line	Low Pressure	mm	φ28.58	φ28.58	φ28.58	
		High/Low Pressure	mm	φ22.2	φ25.4	φ25.4	
Package	Dimensions		H×W×D	mm	1,800×1,680×810	1,800×1,680×810	
	Measurement		m ³	2.4	2.4	2.4	

Notes:

- The cooling and heating performances are the values when combined with our specified indoor units.

Cooling Operation Conditions	Heating Operation Conditions
Indoor Air Inlet Temperature: 27.0°C DB	Indoor Air Inlet Temperature: 20.0°C DB
19.0°C WB	Outdoor Air Inlet Temperature: 7.0°C DB
Outdoor Air Inlet Temperature: 35°C DB	6.0°C WB

Piping Length: 7.5 metres Piping Length: 7.5 metres
Piping Lift: 0 metres Piping Lift: 0 metres
- The sound pressure is based on the following conditions.
The above data is based on the cooling mode. In case of heating mode, the sound pressure level increases by approximately 1~2 dB.
The above data was measured in an anechoic chamber so that reflected sound should be taken into consideration in the field.
- The width of outer dimension, it is the value when each distance between the base outdoor units is specified to 20mm.



26

28

30



32

34

36

HP class

Model

			RAS-26FSXNS	RAS-28FSXNS	RAS-30FSXNS	RAS-32FSXNS	RAS-34FSXNS	RAS-36FSXNS		
Combination of Base Unit			RAS-12FSXNS RAS-14FSXNS	RAS-12FSXNS RAS-16FSXNS	RAS-12FSXNS RAS-18FSXNS	RAS-14FSXNS RAS-18FSXNS	RAS-16FSXNS RAS-18FSXNS	RAS-18FSXNS RAS-18FSXNS		
Power Supply			AC 3φ, [400V/50Hz] [380-415V/50Hz] [380V/60H] [220V/60Hz]							
Nominal Cooling Capacity			kW	73.0	77.5	85.0	90.0	95.0	100.0	
Nominal Heating Capacity			kW	82.5	90.0	95.0	100.0	106.0	112.0	
Cabinet	Colour	Munsell Code	Natural Gray (1.0Y 8.5/0.5)							
	Outer Dimensions	H×W×D	mm	1,675×2,180×765	1,675×2,180×765	1,675×2,180×765	1,675×2,440×765	1,675×2,440×765	1,675×2,440×765	
Sound Level	Sound Power Level		dB(A)	87	87	87	89	89	89	
	Sound Pressure Level		dB(A)	64.5	64.5	66	67	67	68	
Weight	Net Weight	400V/50Hz	kg	215+271	215+314	215+315	271+315	314+315	315+315	
		380-415V/50Hz	kg							
	Gross Weight	220V/60Hz	kg	210+266	210+309	210+310	266+310	309+310	310+310	
		400V/50Hz	kg	231+289	231+332	231+333	289+333	332+333	333+333	
Refrigerant	Type			R410A						
	Flow Control			Micro-Computer Control Expansion Valve						
	Charge (before Shipment)		kg	16.1	17.1	17.9	19.6	20.6	21.4	
Compressor	Type			Hermetic (Scroll)						
	Model			DC80PHD+DC80PHD	DC80PHD+AA50PHD +AA50PHD	DC80PHD+AA50PHD +AA50PHD	DC80PHD+AA50PHD +AA50PHD	AA50PHD+AA50PHD +AA50PHD	AA50PHD+AA50PHD +AA50PHD	
	Quantity			2	3	3	3	4	4	
	Motor Output (Pole)			kW	5.4(6)×1+8.0(6)×1	5.4(6)×1+4.5(6)×2	5.4(6)×1+5.0(6)×2	8.0(6)×1+5.0(6)×2	4.5(6)×2+5.0(6)×2	5.0(6)×2+5.0(6)×2
Refrigeration Oil	Type			FVC68D						
	Charge		L/Unit	12.9	13.9	13.9	14.8	15.8	15.8	
Heat Exchanger				Multi-Pass Cross-Finned Tube						
Condenser Fan	Type			Propeller Fan						
	Quantity			3	3	3	4	4	4	
	Air Flow Rate			m³/min.	190+239	190+256	190+256	239+256	256×2	256×2
	Motor Output (Pole)			kW	0.42(8) +0.33(8)×2	0.42(8) +0.39(8)×2	0.42(8) +0.39(8)×2	0.33(8)×2 +0.39(8)×2	0.39(8)×2 +0.39(8)×2	0.39(8)×2 +0.39(8)×2
Main Refrigerant Piping	Liquid Line			mm						
	Gas Line			mm						
Heat Recovery System (3 Pipes)	Low Pressure			mm						
	High/Low Pressure			mm						

Notes:

- The cooling and heating performances are the values when combined with our specified indoor units.
 Cooling Operation Conditions: Indoor Air Inlet Temperature: 27.0°C DB, 19.0°C WB, Outdoor Air Inlet Temperature: 35°C DB
 Heating Operation Conditions: Indoor Air Inlet Temperature: 20.0°C DB, Outdoor Air Inlet Temperature: 7.0°C DB, 6.0°C WB
 Piping Length: 7.5 metres, Piping Lift: 0 metres
- The sound pressure is based on the following conditions.
 The above data is based on the cooling mode. In case of heating mode, the sound pressure level increases by approximately 1-2 dB.
 The above data was measured in an anechoic chamber so that reflected sound should be taken into consideration in the field.
- Except for the specified combination in the table (26-54HP class 73.0~150.0kW), there is no other combination of the base unit.
- The width of outer dimension, it is the value when each distance between the base outdoor units is specified to 20mm.

SET FREE Σ

SPECIFICATIONS

SPECIFICATIONS

Space saving model: FSXNS series



HP class

Model

			38	40	42	44	46	48	
			RAS-38FSXNS	RAS-40FSXNS	RAS-42FSXNS	RAS-44FSXNS	RAS-46FSXNS	RAS-48FSXNS	
Combination of Base Unit			RAS-14FSXNS RAS-24FSXNS	RAS-18FSXNS RAS-22FSXNS	RAS-18FSXNS RAS-24FSXNS	RAS-22FSXNS RAS-22FSXNS	RAS-22FSXNS RAS-24FSXNS	RAS-24FSXNS RAS-24FSXNS	
Power Supply			AC 3φ, [400V/50Hz] [380-415V/50Hz] [380V/60Hz] [220V/60Hz]						
Nominal Cooling Capacity			kW	106.0	112.0	118.0	122.0	128.0	136.0
Nominal Heating Capacity			kW	118.0	125.0	132.0	140.0	145.0	150.0
Cabinet	Colour	Munsell Code	Natural Gray (1.0Y 8.5/0.5)						
	Outer Dimensions	H×W×D	mm	1,675×2,830×765	1,675×2,830×765	1,675×2,830×765	1,675×3,220×765	1,675×3,220×765	1,675×3,220×765
Sound Level	Sound Power Level		dB(A)	89	88	89	87	88	89
	Sound Pressure Level		dB(A)	68	67.5	68.5	67	68	69
Weight	Net Weight	400V/50Hz	kg	271+370	315+369	315+370	369+369	369+370	370+370
		380-415V/50Hz	kg						
	220V/60Hz	kg	266+365	310+364	310+365	364+364	364+365	365+365	
	Gross Weight	400V/50Hz	kg	289+390	333+389	333+390	389+389	389+390	390+390
380-415V/50Hz		kg							
Refrigerant	Type			R410A					
	Flow Control			Micro-Computer Control Expansion Valve					
	Charge (before Shipment)	kg		20.5	22.0	22.3	22.6	22.9	23.2
Compressor	Type			Hermetic (Scroll)					
	Model			DC80PHD+DC80PHD +DC80PHD	AA50PHD+AA50PHD +DC80PHD+DC80PHD	AA50PHD+AA50PHD +DC80PHD+DC80PHD	DC80PHD+DC80PHD +DC80PHD+DC80PHD	DC80PHD+DC80PHD +DC80PHD+DC80PHD	DC80PHD+DC80PHD +DC80PHD+DC80PHD
	Quantity			3	4	4	4	4	4
	Motor Output (Pole)		kW	8.0(6)×1+7.1(6)×2	5.0(6)×2+6.7(6)×2	5.0(6)×2+7.1(6)×2	6.7(6)×2+6.7(6)×2	6.7(6)×2+7.1(6)×2	7.1(6)×2+7.1(6)×2
Refrigeration Oil	Type			FVC68D					
	Charge	L/Unit		15.3	16.3	16.3	16.8	16.8	16.8
Heat Exchanger			Multi-Pass Cross-Finned Tube						
Condenser Fan	Type			Propeller Fan					
	Quantity			4	4	4	4	4	4
	Air Flow Rate		m³/min.	239+348	256+329	256+348	329×2	329+348	348×2
	Motor Output (Pole)		kW	0.33(8)×2 +0.56(8)×2	0.39(8)×2 +0.48(8)×2	0.39(8)×2 +0.56(8)×2	0.48(8)×2 +0.48(8)×2	0.48(8)×2 +0.56(8)×2	0.56(8)×2 +0.56(8)×2
Main Refrigerant Piping	Liquid Line		mm	φ19.05					
	Gas Line	Low Pressure	mm	φ38.1					
Heat Recovery System (3 Pipes)		High/Low Pressure	mm	φ31.75					

Notes:

1. The cooling and heating performances are the values when combined with our specified indoor units.

Cooling Operation Conditions

Indoor Air Inlet Temperature: 27.0°C DB

19.0°C WB

Outdoor Air Inlet Temperature: 35°C DB

Piping Length: 7.5 metres

Piping Lift: 0 metres

Heating Operation Conditions

Indoor Air Inlet Temperature: 20.0°C DB

Outdoor Air Inlet Temperature: 7.0°C DB

6.0°C WB

Piping Length: 7.5 metres

Piping Lift: 0 metres

2. The sound pressure is based on the following conditions.

The above data is based on the cooling mode. In case of heating mode, the sound pressure level increases by approximately 1~2 dB.

The above data was measured in an anechoic chamber so that reflected sound should be taken into consideration in the field.

3. Except for the specified combination in the table (26~54HP class 73.0~150.0kW), there is no other combination of the base unit.

4. The width of outer dimension, it is the value when each distance between the base outdoor units is specified to 20mm.



HP class

50

52

54

Model

RAS-50FSXNS

RAS-52FSXNS

RAS-54FSXNS

Combination of Base Unit		RAS-14FSXNS RAS-18FSXNS RAS-18FSXNS	RAS-16FSXNS RAS-18FSXNS RAS-18FSXNS	RAS-18FSXNS RAS-18FSXNS RAS-18FSXNS	
Power Supply		AC 3φ, [400V/50Hz] [380-415V/50Hz] [380V/60H] [220V/60Hz]			
Nominal Cooling Capacity		kW 140.0	145.0	150.0	
Nominal Heating Capacity		kW 155.0	160.0	165.0	
Cabinet	Colour	Natural Gray (1.0Y 8.5/0.5)			
	Munsell Code				
Outer Dimensions	H×W×D	mm 1,675×3,670×765	1,675×3,670×765	1,675×3,670×765	
Sound Level	Sound Power Level	dB(A) 90	90	91	
	Sound Pressure Level	dB(A) 69	69	70	
Weight	Net Weight	400V/50Hz	271+315+315	314+315+315	
		380-415V/50Hz			
	Gross Weight	220V/60Hz	266+310+310	309+310+310	310+310+310
		400V/50Hz			
	380-415V/50Hz	289+333+333	332+333+333	333+333+333	
	220V/60Hz	284+328+328	327+328+328	328+328+328	
Refrigerant	Type	R410A			
	Flow Control	Micro-Computer Control Expansion Valve			
	Charge (before Shipment)	kg 30.3	31.3	32.1	
Compressor	Type	Hermetic (Scroll)			
	Model	DC80PHD+AA50PHD+AA50PHD +AA50PHD+AA50PHD	AA50PHD+AA50PHD+AA50PHD +AA50PHD+AA50PHD+AA50PHD	AA50PHD+AA50PHD+AA50PHD +AA50PHD+AA50PHD+AA50PHD	
	Quantity	5	6	6	
	Motor Output (Pole)	kW 8.0(6)×1+5.0(6)×2 +5.0(6)×2	4.5(6)×2+5.0(6)×2 +5.0(6)×2	5.0(6)×2+5.0(6)×2 +5.0(6)×2	
Refrigeration Oil	Type	FVC68D			
	Charge	L/Unit 22.7	23.7	23.7	
Heat Exchanger		Multi-Pass Cross-Finned Tube			
Condenser Fan	Type	Propeller Fan			
	Quantity	6	6	6	
	Air Flow Rate	m³/min. 239+256×2	256×3	256×3	
Motor Output (Pole)	kW 0.33(8)×2+0.39(8)×2 +0.39(8)×2	0.39(8)×2+0.39(8)×2 +0.39(8)×2	0.39(8)×2+0.39(8)×2 +0.39(8)×2	0.39(8)×2+0.39(8)×2 +0.39(8)×2	
Main Refrigerant Piping		Liquid Line	mm φ19.05	φ19.05	
Heat Recovery System (3 Pipes)	Gas Line	Low Pressure	mm φ38.1	φ38.1	
		High/Low Pressure	mm φ31.75	φ31.75	

Notes:

- The cooling and heating performances are the values when combined with our specified indoor units.
Cooling Operation Conditions: Indoor Air Inlet Temperature: 27.0°C DB, 19.0°C WB, Outdoor Air Inlet Temperature: 35°C DB, Piping Length: 7.5 metres, Piping Lift: 0 metres
Heating Operation Conditions: Indoor Air Inlet Temperature: 20.0°C DB, Outdoor Air Inlet Temperature: 7.0°C DB, 6.0°C WB, Piping Length: 7.5 metres, Piping Lift: 0 metres
- The sound pressure is based on the following conditions.
The above data is based on the cooling mode. In case of heating mode, the sound pressure level increases by approximately 1~2 dB.
The above data was measured in an anechoic chamber so that reflected sound should be taken into consideration in the field.
- Except for the specified combination in the table (26~54HP class 73.0~150.0kW), there is no other combination of the base unit.
- The width of outer dimension, it is the value when each distance between the base outdoor units is specified to 20mm.

OPTIONAL PARTS FOR HEAT RECOVERY TYPE

PIPING CONNECTION KIT

Piping connection kit for the divergence between outdoor units

Model	Applicable ODU		Connectivity Number	Remarks
	HP class			
	FSXNP series	FSXNS series		
MC-NP20SX1	20-24	-	2	for Low Pressure Gas: 1 for High/Low Pressure Gas: 1
MC-NP21SX1	26-36	26-48	2	for Liquid: 1
MC-NP30SX1	38-54	50-54	3	for Low Pressure Gas: 2 for High/Low Pressure Gas: 2 for Liquid: 2

NOTE:
The old model (MC-TTA1) is not available.

Example: MC-NP21SX1

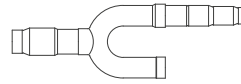

Branch Pipe for Low Pressure Gas Line

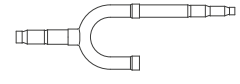

Branch Pipe for Liquid Line

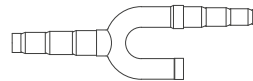

Branch Pipe for High/Low Pressure Gas Line

MULTI-KIT

Branching for indoor and outdoor connecting pipes

Line branch

(First branch)

Model	ODU Capacity	
	HP class	kW
MW-NP282X3	8-10	22.4-28.0
MW-NP452X3	12-16	33.5-45.0
MW-NP562X3	18-20	50.0-56.0
MW-NP692X3	22-24	61.5-67.0
MW-NP902X3	26-54	73.0-150.0

Example: MW-NP282X3

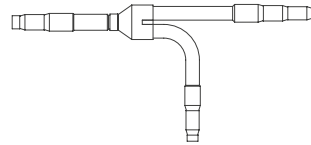

Low Pressure Gas Side
High/Low Pressure Gas Side

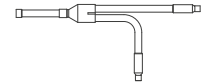

Liquid Side

(After first branch)

3 pipes portion

Model	Total IDU HP class	Diameter (mm)			Remarks
		Gas Pipe	High/Low Pressure Gas Pipe	Liquid Pipe	
MW-NP142X3	< 6	φ15.88	φ12.7	φ9.52	
MW-NP282X3	6-8.99	φ19.05	φ15.88	φ9.52	
	9-11.99	φ22.2	φ19.05	φ9.52	
MW-NP452X3	12-15.99	φ25.4	φ22.2	φ12.7	
	16-17.99	φ28.58	φ22.2	φ12.7	For 3 pipes
MW-NP562X3	18-21.99	φ28.58	φ22.2	φ15.88	
MW-NP692X3	22-25.99	φ28.58	φ25.4	φ15.88	
MW-NP902X3	26-35.99	φ31.75	φ28.58	φ19.05	
	≥ 36	φ38.1	φ31.75	φ19.05	

2 pipes portion

Model	Total IDU HP class	Diameter (mm)		Remarks
		Gas Pipe	Liquid Pipe	
MW-NP282A3	< 6	φ15.88	φ9.52	
	6-8.99	φ19.05	φ9.52	
	9-11.99	φ22.2	φ9.52	
MW-NP452A3	12-15.99	φ25.4	φ12.7	
	16-17.99	φ28.58	φ12.7	For 2 pipes
MW-NP692A3	18-25.99	φ28.58	φ15.88	
MW-NP902A3	26-35.99	φ31.75	φ19.05	
	≥ 36	φ38.1	φ19.05	

Header branch

Model	Total IDU HP class	No. of Header Branches	Remarks
MH-NP288X	5-10	8	For 3 pipes
MH-NP224A	5-8	4	For 2 pipes
MH-NP288A	5-10	8	

Example: MH-NP288X

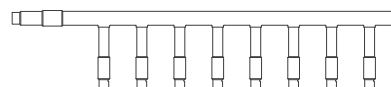



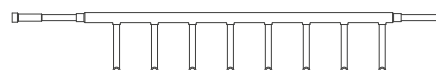

Low Pressure Gas Side
High Pressure Gas Side



Liquid Side

CH-BOX

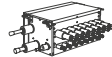
Specifications

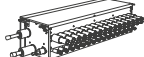
Type		Single-Port		Multi-Port				
Model								
		CH-AP160SSX	CH-AP280SSX	CH-AP04MSSX	CH-AP08MSSX	CH-AP12MSSX	CH-AP16MSSX	
Dimensions (H×W×D)	mm	191×301×214	191×301×214	260×303×352	260×543×352	260×783×352	260×1,023×352	
N/W	kg	6	6	14	25	36	47	
Electrical Details	Power Supply	1~/N, [220-240V/50Hz]						
	Power Input	W	5	5	11.2	22.4	33.6	44.8
	Current	A	0.1	0.1	0.2	0.4	0.6	0.8
Maximum Total Capacity Index	kW	16	28	44.8	85	85	85	
Number of Port (for IDU)		1	1	4	8	12	16	
Maximum Connectable IDUs per Port		7	8	6	6	6	6	
Maximum Piping length	Total piping length between CH-Box and each indoor unit per branch	m	40	40	40	40	40	40
	Between CH-Boxes	m	15	15	15	15	15	15
Maximum Height difference	Between CH-Box and IDU	m	15	15	15	15	15	15
	Between IDUs connecting to same CH-Box	m	4	4	4	4	4	4

DRAIN BOSS

The drain boss is for the drain pipe connection in order to use the bottom base of the outdoor unit as a drain pan.

Quantity

Model	ODU HP class (kW)	Q'ty
DBS-TP10A	8-18(22.4-50.0)	1
	20-36(56.0-100.0)	2
	38-40(106.0-112.0)	3
	42-48(118.0-136.0)	4
	50-54(140.0-150.0)	3

DBS-TP10A

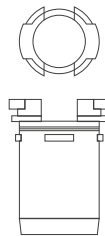

Drain Boss×2

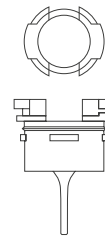

Drain Cap×2
To close the drain hole

CABINET COVER

Protection net

HP class (kW)		Rear	Right	Left
FSXNP series	FSXNS series			
5-6(14.0-16.0)	8-12(22.4-33.5)	PN-TP20BA	PN-TP20R	PN-TP20L
8-14(22.4-40.0)	14-18(40.0-50.0)	PN-TP20BB	PN-TP20R	PN-TP20R
16-18(45.0-50.0)	20-24(56.0-67.0)	PN-TP20BC	PN-TP20R	PN-TP20R

Image

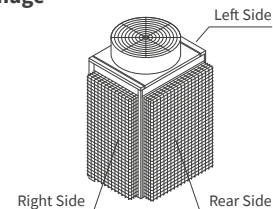





**VRF
INDOOR UNITS
& VENTILATION**

SET FREE Σ

INDEX

53	LINE UP OVERVIEW
-----------	-------------------------

57	DUCTED
57	HIGH ESP TYPE (EXTERNAL STATIC PRESSURE TYPE) [RPI-FSN3, RPI-FSN1]
58	MEDIUM ESP TYPE (EXTERNAL STATIC PRESSURE TYPE)
59	HIGH ESP TYPE (EXTERNAL STATIC PRESSURE TYPE) [RPIH-HNAUNQ]
60	COMPACT TYPE
62	LARGER AIR VOLUME TYPE

63	CONCEALED & EXPOSED
63	WALL MOUNTED TYPE
64	FLOOR/CEILING CONVERTIBLE TYPE
65	CEILING SUSPENDED TYPE
66	FLOOR EXPOSED TYPE
67	FLOOR CONCEALED TYPE

68	CEILING CASSETTE
68	4-WAY CASSETTE TYPE [RCI-FSN3]
69	4-WAY CASSETTE TYPE [RCI-FSKDNQ]
70	4-WAY CASSETTE COMPACT TYPE
71	2-WAY CASSETTE TYPE
72	1-WAY CASSETTE TYPE

73	VENTILATIONS
73	ALL FRESH AIR UNIT
74	TOTAL HEAT EXCHANGER

LINE UP OVERVIEW

COMPARING VRF INDOOR UNIT RANGE

IDU Category	Cooling (kW)	1.6	1.7	2.2	2.8	3.6	4.0	5.0	5.6	6.3	7.1	8.0	8.4	9.0	11.2	14.0	14.2	16.0	18.0	22.4	28.0		
DUCTED	HIGH ESP TYPE [RPI-FSN3, RPI-FSN1]								•		•	•				•	•		•		•	•	
	MEDIUM ESP TYPE				•	•		•	•		•	•				•	•		•				
	HIGH ESP TYPE [RPIH-HNAUNQ]													•	•	•		•	•				
	COMPACT TYPE (BOTH AC MOTOR TYPE AND DC MOTOR TYPE AVAILABLE)				•	•	•	•	•	•	•	•											
	LARGER AIR VOLUME TYPE												•				•	•		•	•		
CONCEALED & EXPOSED	WALL MOUNTED TYPE		•	•	•		•		•		•	•				•							
	FLOOR / CEILING CONVERTIBLE TYPE							•	•	•	•		•	•	•		•						
	CEILING SUSPENDED TYPE							•	•		•	•				•	•		•				
	FLOOR EXPOSED TYPE					•		•		•		•											
	FLOOR CONCEALED TYPE					•		•		•		•											
	CEILING CASSETTE	4-WAY CASSETTE TYPE [RCI-FSN3, RCI-FSKDNQ]					•		•		•	•					•	•		•			
4-WAY CASSETTE COMPACT TYPE			•		•	•		•		•	•												
2-WAY CASSETTE TYPE					•	•		•		•	•					•	•		•				
1-WAY CASSETTE TYPE					•	•		•		•	•												

COMPARING VENTILATION CAPACITY

Fan Air Flow Rate (m ³ /h)	165	250	350	500	670	800	870	1,000	1,080	1,680	2,100	3,000	4,020	4,980	6,000	
ALL FRESH AIR UNIT																
TOTAL HEAT EXCHANGER	•	•	•	•	•	•	•	•	•							

KEY INFORMATION

FEATURES TO SUIT YOUR PROJECT SPACE

The new SET FREE Σ range offers our widest choice of indoor units to give you the versatility to complement any interior.

DUCTED



- HIGH ESP TYPE**
[RPI-FSN3, RPI-FSN1]
- High external static pressure available: Up to 200Pa for RPI-2.0-6.0FSN3 model, up to 230Pa for RPI-8.0/10.0FSN1 model
 - You have more design flexibility with both rear and bottom air suction directions available
 - Setback temperature control available, leading to better operation.
 - Dual set-point for greater simultaneous cooling & heating operation



- MEDIUM ESP TYPE**
- 3 steps of static pressure (50/100/150 Pa) available
 - You have more design flexibility with both rear and bottom air suction directions available
 - Setback temperature control available, leading to better operation.
 - Dual set-point for greater simultaneous cooling & heating operation



- HIGH ESP TYPE**
[RPIH-HNAUNQ]
- High ESP (90/120Pa)
 - Space saving design thanks to a height of only 300mm



- COMPACT TYPE**
(BOTH AC MOTOR TYPE AND DC MOTOR TYPE AVAILABLE)
- Ideal for installation over the closet or windows thanks to the up to the compactness with 192mm height
 - Drain-pump with 900mm lift as standard optional part
 - Quiet operation level (as low as 20dB(A))
 - Fan air flow rate up to 6 taps (DC motor model only)



- LARGER AIR VOLUME TYPE**
- Two external static pressure settings for better flexibility
 - High external static pressure: Up to 120Pa (140Pa in 7HP class)
 - Suitable for air distribution for multiple zone

CONCEALED & EXPOSED



- WALL MOUNTED TYPE**
- Simple installation procedure
 - Flexible discreet design suitable for any interior
 - Without expansion-valve model available for 0.6-1.5 for more silent indoor space
 - Setback temperature control available, leading to better operation.
 - Dual set-point for greater simultaneous cooling & heating operation



- FLOOR/CEILING CONVERTIBLE TYPE**
- Each unit can be floor mounted or ceiling suspended
 - Easy installation
 - Fresh air-intake design
 - Optional drain pump available



- CEILING SUSPENDED TYPE**
- Ideal for a higher ceiling (up to 5.6m in cooling)
 - Better power-saving with optional Motion Sensor
 - Quiet operation level (as low as 28dB(A))
 - Setback temperature control available, leading to better operation.
 - Dual set-point for greater simultaneous cooling & heating operation



- FLOOR EXPOSED TYPE**
- Easy installation
 - Little installation space required, with only 220mm depth
 - Suitable for installation under a window, with a 630mm height



- FLOOR CONCEALED TYPE**
- When there is no ceiling void, this unit gives you a minimal, low visibility option as it can be installed in floor cavities and walls
 - Little installation space required, with only 220mm depth
 - Suitable for installation under a window, with a 620mm height

CEILING CASSETTE



- 4-WAY CASSETTE TYPE**
[RCI-FSN3]
- You can distribute air over longer distances with individual four-way louvres that can accommodate optional duct flanges
 - Motion sensor available for better energy saving operation
 - Ideal for a higher ceiling location for installation (up to 5.5m in cooling mode)
 - Setback temperature control available, leading to better operation.
 - Dual set-point for greater simultaneous cooling & heating operation



- 4-WAY CASSETTE TYPE**
[RCI-FSKDNQ]
- With area of air distribution with 4 direction of louvres (distribution with distance available with optional parts (duct flange))
 - Motion sensor available for better energy saving operation
 - Individual four-way louvres for greater comfort for individual users
 - Ideal for a higher ceiling location for installation (up to 5.5m in cooling mode)



- 4-WAY CASSETTE COMPACT TYPE**
- Made to give you greater design flexibility as the dimensions fit 600mmx600mm architectural module ceiling specifications
 - Quiet operation level (as low as 24.5dB(A))
 - Wide range of air flow rate ideal for high ceiling installation with 4.6m air blow down in cooling mode
 - Setback temperature control available, leading to better operation.
 - Dual set-point for greater simultaneous cooling & heating operation



- 2-WAY CASSETTE TYPE**
- Motion sensor available for better energy saving operation
 - Ideal for a higher ceiling location for installation (up to 4.6m in cooling mode)
 - Individually operated louvres give room occupants more comfort
 - Quiet operation level (as low as 27dB(A))
 - Setback temperature control available, leading to better operation.
 - Dual set-point for greater simultaneous cooling & heating operation

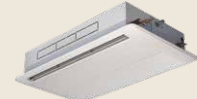

- 1-WAY CASSETTE TYPE**
- Motion sensor available for better energy saving operation
 - Optimum air flow conditions are created by either downward air discharge or frontal air discharge (via optional grille)
 - Quiet operation level (as low as 27dB(A))
 - Setback temperature control available, leading to better operation.
 - Dual set-point for greater simultaneous cooling & heating operation

VENTILATIONS













- ALL FRESH AIR UNIT**
- Creates a comfortable and healthy indoor environment thanks to introducing fresh air function and heat/cool function
 - Various controllers can be selected and interfaced with the H-LINK system
 - Longer ducts can be connected on-site, thanks to the higher ESP



- TOTAL HEAT EXCHANGER**
- Creates a healthy indoor environment thanks to introducing fresh air function and ventilation function
 - Remote controller for Total Heat Exchanger is equipped in unit as standard part

LINE UP OVERVIEW

FEATURES COMPARISON

Model		HIGH/MEDIUM ESP TYPE	HIGH ESP TYPE (8/10HP)	HIGH ESP TYPE	COMPACT TYPE (AC)	COMPACT TYPE (DC)	
		 RPI-FSN3 RPIM-FSN3	 RPI-FSN1	 RPIH-HNAUNQ	 RPIZ-HNATNQ	 RPIZ-HNDTSQ	
 COMFORT	Temperature Setting Rate	0.5°C/1.0°C	0.5°C/1.0°C	1.0°C	1.0°C	1.0°C	
	Indoor Fan Speed	4 taps	4 taps	3 taps	3 taps	6 taps	
	Louvre Direction	-	-	-	-	-	
	Individual Louvre Setting	-	-	-	-	-	
	Auto Louvre Setting	-	-	-	-	-	
	Cold Draft Prevention Availability (*1)	●	●	●	●	●	
	Dry mode Availability	●	●	●	●	●	
 POWER-SAVING	Power Saving with Motion Sensor (*2)	●	●	-	-	-	
	Outdoor Unit capacity control (*2)	Peak cut control	●	●	-	-	-
		moderate control	●	●	-	-	-
	Indoor Unit Rotation Control (*2)	Indoor Unit Address	●	●	-	-	-
		Indoor Air Temperature difference	●	●	-	-	-
	Automatic Fan Operation	●	●	●	●	●	
 MENU	Quick Function	●	●	-	-	-	
	Comfort setting	●	●	-	-	-	
	Daylight Saving Time	●	●	●	●	●	
	Power Consumption visualisation	●	●	-	-	-	
	Weekly Schedule Setting	●	●	●	●	●	
	Power-Saving Setting	●	●	-	-	-	
 MAINTENANCE	Dirty Filter Notice Availability	●	●	●	●	●	
	Check Menu	Sensor Condition Check	●	●	●	●	●
		Model Display (*2)	●	●	-	-	-
		Indoor/Outdoor PCB Check	●	●	●	●	●
		Alarm History Display	●	●	●	●	●
 OPTIONAL ACCESSORY	Coloured Decoration Panel availability	-	-	-	-	-	
	Motion Sensor	SOR-NEZ	SOR-NEZ	-	-	-	
	Receiver Kit for wireless remote controller	PC-ALHZ1	PC-ALHZ1	PC-ALHZ1	PC-ALHZ1	PC-ALHZ1	
	Drain-up mechanism availability	● (*3)	● (*3)	DUPI-361Q	● (*3)	● (*3)	
	Fresh air intake accessory	-	-	-	-	-	
	Air filter	F-56/90/160LI B-56/90/160LI	F-280LI B-280LI	KW-PP9/10Q	KW-PP5Q KW-PP6Q	KW-PP5Q KW-PP6Q	
	Strainer kit	-	-	-	-	-	

LARGER AIR VOLUME TYPE	WALL MOUNTED TYPE	FLOOR/CEILING CONVERTIBLE TYPE	CEILING SUSPENDED TYPE	FLOOR EXPOSED TYPE	FLOOR CONCEALED TYPE	4-WAY CASSETTE TYPE	4-WAY CASSETTE COMPACT TYPE	2-WAY CASSETTE TYPE	1-WAY CASSETTE TYPE	
RPI-FSN2SQ	RPK-FSN4M RPK-FSNH4M	RPFC-FSNQ	RPC-FSN3	RPF-FSN2E	RPFI-FSN2E	RCI-FSN3	RCI-FSKDNQ	RCIM-FSN4	RCD-FSN3	RCS-FSN
1.0°C	0.5°C/1.0°C	1.0°C	0.5°C/1.0°C	1.0°C	1.0°C	0.5°C/1.0°C	0.5°C/1.0°C	0.5°C/1.0°C	0.5°C/1.0°C	0.5°C/1.0°C
3 taps	4 taps	3 taps	4 taps	3 taps	3 taps	4 taps	4 taps	4 taps	4 taps	4 taps
-	7 (*5)	7 (*5)	7 (*5)	-	-	7 (*4)	7 (*4)	7 (*4)	7 (*4)	7 (*5)
-	-	-	-	-	-	●	●	●	●	-
-	-	-	-	-	-	●	●	●	●	-
●	●	●	●	●	●	●	●	●	●	●
●	●	●	●	●	●	●	●	●	●	●
-	-	-	●	-	-	●	●	●	●	●
-	●	-	●	-	-	●	●	●	●	●
-	●	-	●	-	-	●	●	●	●	●
-	●	-	●	-	-	●	●	●	●	●
-	●	-	●	-	-	●	●	●	●	●
●	●	●	●	●	●	●	●	●	●	●
-	●	-	●	-	-	●	●	●	●	●
-	●	-	●	-	-	●	●	●	●	●
●	●	●	●	●	●	●	●	●	●	●
-	●	-	●	-	-	●	●	●	●	●
●	●	●	●	●	●	●	●	●	●	●
●	●	●	●	●	●	●	●	●	●	●
-	●	-	●	-	-	-	-	-	●	●
●	●	●	●	●	●	●	●	●	●	●
●	●	●	●	●	●	●	●	●	●	●
-	-	-	-	-	-	● (*6)	-	-	● (*6)	● (*6)
-	-	-	SOR-NEP	-	-	P-AP160NAE	PS-MSK2	SOR-NEC	SOR-NED	SOR-NES
PC-ALHZ1	PC-ALHZ1	PC-ALHZ1	PC-ALHP1	PC-ALHZ1	PC-ALHZ1	PC-ALH3	PC-ALH3	PC-ALHC1	PC-ALHD1	PC-ALHS1
-	-	-	DUPC-63K1 DUPC-71K1 DUPC-160K1	-	-	● (*3)	● (*3)	● (*3)	● (*3)	● (*3)
-	-	-	-	-	-	● (*7)	-	● (*7)	● (*7)	● (*7)
-	-	-	-	-	-	F-71L-D1 F-160L-D1 B-160H2 F-160L-K	-	-	F-90MD-K1 F-160MD-K1 B-90HD B-160HD	-
-	MSF-NP63A1 MSF-NP112A1 MSF-NP36AH1	-	-	-	-	-	-	-	-	-

(*1) This function is utilised to prevent cold discharged air at start-up of heating operation, after defrosting operation, etc. The fan speed automatically switches from Slow to Low and then to the set fan speed. The fan operation might be stopped for up to 2 minutes. At this time the louvre is fixed horizontally.
 (*2) Advanced wired remote controller PC-ARF1 needs to be connected.
 (*3) Included as standard equipment.

(*4) 7 steps are available by individual louvre setting. 5 steps only in the operation of Cooling or Dry.
 (*5) 5 steps only in the operation of Cooling or Dry.
 (*6) 3 colours available except white (Beige, Grey and Black).
 (*7) Optional parts: Duct Adapter is available. Please consult your distributor.

SET FREE Σ

LINE UP OVERVIEW



HIGH ESP TYPE (EXTERNAL STATIC PRESSURE TYPE) [RPI-FSN3, RPI-FSN1]



FEATURES AND BENEFITS



- Setback temperature control available, leading to better operation.
- Dual set-point for greater simultaneous cooling & heating operation

Fits a standard drain pump with 850 mm lift

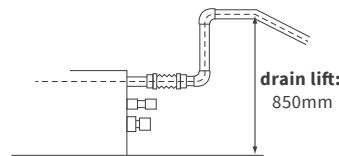

Air Inlet can be chosen from two locations

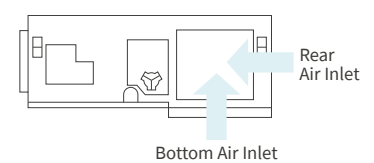

GENERAL DATA & ACCESSORIES

Model		RPI-2.0FSN3	RPI-2.5FSN3	RPI-3.0FSN3	RPI-4.0FSN3	RPI-5.0FSN3	RPI-6.0FSN3	RPI-8.0FSN1	RPI-10.0FSN1
Indoor Unit Power Supply		AC 1Φ, [220-240V/50Hz] [220V/60Hz]							
Nominal Cooling Capacity	kW	5.6	7.1	8.0	11.2	14.0	16.0	22.4	28.0
Nominal Heating Capacity	kW	6.3	8.5	9.0	12.5	16.0	18.0	25.0	31.5
Sound Pressure Level (Overall A Scale)(Hi/Hi/Me/Lo)	dB(A)	41/38/35/32	37/35/32/30	39/36/33/31	40/37/34/32	42/39/36/33	44/40/37/34	44/40/37/34	44/40/37/34
Sound Power Level (Overall A Scale)(Hi/Hi/Me/Lo)	dB(A)	59/56/53/50	55/53/50/48	57/54/51/49	58/55/52/50	60/57/54/51	62/58/55/52	65/62/59/56	67/64/61/58
Outer Dimensions H×W×D	mm	300×700×800	300×1,050×800	300×1,050×800	300×1,400×800	300×1,400×800	300×1,400×800	470×1,380×1,060	470×1,380×1,060
Net Weight	kg	29	38	38	48	48	48	94	94
Refrigerant		R410A	R410A	R410A	R410A	R410A	R410A	R410A	R410A
Indoor Fan Air Flow Rate (Hi/Hi/Me/Lo)	m ³ /min (cfm)	14.5/13/11/9.5 (512/459/388/335)	18.5/16.5/14.5/12 (653/582/512/423)	20/17.5/15.5/13 (706/618/547/459)	30/26.5/23/20 (1,059/935/812/706)	33.5/29.5/26/22 (1,182/1,041/917/776)	36/31.5/27.5/24 (1,270/1,112/970/847)	63/58/50/38 (2,224/2,048/1,765/1,341)	80/72/64/48 (2,825/2,542/2,260/1,695)
External Pressure (*3)	Pa	50(100-200)	50(100-200)	50(100-200)	50(100-200)	50(100-200)	50(100-200)	50(100-230)	50(100-230)
Motor	W	157	190	190	259	259	259	840	840
Connections	m ³	Flare-Nut Connection (with Flare Nuts)							
Refrigerant Piping	Liquid Line	mm	Φ6.35	Φ9.52	Φ9.52	Φ9.52	Φ9.52	Φ9.52	Φ9.52
	Gas Line	mm	Φ12.7	Φ15.88	Φ15.88	Φ15.88	Φ15.88	Φ19.05	Φ22.2
	Condensate Drain		VP25	VP25	VP25	VP25	VP25	VP25	VP25
Approximate Packing Measurement	m ³	0.28	0.39	0.39	0.50	0.50	0.50	0.97	0.97

Receiver kit	PC-ALHZ1
Motion Sensor	SOR-NEZ
Condensate Drain Pump Kit	- (included as standard equipment)
Antifungal Long-Life Filter	2.0 (HP Class) F-56LI 2.5-3.0 (HP Class) F-90LI 4.0-6.0 (HP Class) F-160LI

Filter Box for Long-Life Filter	2.0 (HP Class) B-56LI 2.5-3.0 (HP Class) B-90LI 4.0-6.0 (HP Class) B-160LI
Long-Life Filter Kit/Long-Life Filter	8.0-10.0 (HP Class) F-280LI
Motion Filter Box Sensor	8.0-10.0 (HP Class) B-280LI

NOTES:

1. The nominal cooling capacity is the combined capacity of the Hitachi standard split system, and is based on the JIS standard B8616.

Cooling Operation Conditions		Heating Operation Conditions	
Indoor Air Inlet Temperature:	27.0°C DB	Indoor Air Inlet Temperature:	20.0°C DB
	19.0°C WB	Outdoor Air Inlet Temperature:	7.0°C DB
Outdoor Air Inlet Temperature:	35.0°C DB		6.0°C WB
Piping Length:7.5 metre		Piping Length:7.5 metre	
Piping Lift:0 metre		Piping Lift:0 metre	

2. The sound pressure level is based on following conditions. 1.5 metre Beneath the Unit. With Discharge Duct (2.0 metre) and Return Duct (1.0 metre). Voltage of the power source for the indoor fan motor is 220V. The above data was measured in an anechoic chamber so that reflected sound should be taken into consideration in the field.

3. The data for external pressure (*3) indicates "Standard Pressure Setting (High Pressure Setting1 - High Pressure Setting2)" values when a filter is not used. The sound pressure level is based on the Standard Pressure Setting.



MEDIUM ESP TYPE (EXTERNAL STATIC PRESSURE TYPE)



FEATURES AND BENEFITS



- Setback temperature control available, leading to better operation.
- Dual set-point for greater simultaneous cooling & heating operation

Fits a standard drain pump with 850 mm lift

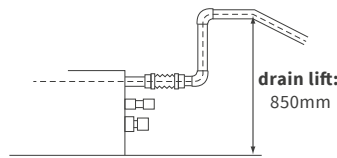

Air Inlet can be chosen from two locations

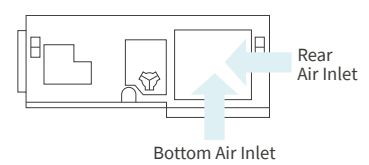

GENERAL DATA & ACCESSORIES

Model	RPIM-0.8FSN3	RPIM-1.0FSN3	RPIM-1.5FSN3	RPIM-2.0FSN3	RPIM-2.5FSN3	RPIM-3.0FSN3	RPIM-4.0FSN3	RPIM-5.0FSN3	RPIM-6.0FSN3	
Indoor Unit Power Supply	AC 1Φ, [220-240V/50Hz] [220V/60Hz]									
Nominal Cooling Capacity	kW	2.2	2.8	4.0	5.6	7.1	8.0	11.2	14.0	16.0
Nominal Heating Capacity	kW	2.5	3.2	4.8	6.3	8.5	9.0	12.5	16.0	18.0
Sound Pressure Level (Overall A Scale)(Hi2/Hi/Me/Lo)	dB(A)	32/30/28/27	33/31/29/28	38/35/32/30	40/37/34/31	37/35/33/31	38/36/33/31	40/38/35/32	42/39/36/34	43/40/37/34
Sound Power Level (Overall A Scale)(Hi2/Hi/Me/Lo)	dB(A)	50/48/46/45	51/49/47/46	56/53/50/48	58/55/52/49	55/53/51/49	56/54/51/49	58/56/53/50	60/57/54/52	61/58/55/52
Outer Dimensions	H×W×D	250×700×800	250×700×800	250×700×800	250×700×800	250×1,050×800	250×1,050×800	250×1,400×800	250×1,400×800	250×1,400×800
Net Weight	kg	26	26	27	27	36	36	44	44	44
Refrigerant		R410A	R410A	R410A	R410A	R410A	R410A	R410A	R410A	R410A
Indoor Fan	Air Flow Rate (Hi2/Hi/Me/Lo)	m³/min (cfm)	8.5/7.5/	9.5/8.5/	13/11.5/	14.5/13/	18.5/16.5/	20/17.5/	30/26.5/	33.5/29.5/
			300/265/229/194)	(335/300/265/229)	(459/406/353/300)	(512/459/388/335)	(653/582/494/423)	(706/618/547/459)	(1,059/935/812/706)	(1,182/1,041/917/776)
External Pressure (*3)	Pa	50(100-150)	50(100-150)	50(100-150)	50(100-150)	50(100-150)	50(100-150)	50(100-150)	50(100-150)	50(100-150)
Motor	W	157	157	157	157	190	190	259	259	259
Connections		Flare-Nut Connection (with Flare Nuts)								
Refrigerant Piping	Liquid Line	mm	Φ6.35	Φ6.35	Φ6.35	Φ6.35	Φ9.52	Φ9.52	Φ9.52	Φ9.52
	Gas Line	mm	Φ12.7	Φ12.7	Φ12.7	Φ12.7	Φ15.88	Φ15.88	Φ15.88	Φ15.88
	Condensate Drain		VP25	VP25	VP25	VP25	VP25	VP25	VP25	VP25
Approximate Packing Measurement	m³	0.24	0.24	0.24	0.24	0.33	0.33	0.42	0.42	0.42
Receiver kit		PC-ALHZ1			0.8-2.0 (HP Class)			B-56LI		
Motion Sensor		SOR-NEZ			2.5-3.0 (HP Class)			B-90LI		
Condensate Drain Pump Kit		-(included as standard equipment)								
Antifungal Long-Life Filter		0.8-2.0 (HP Class)			F-56LI					
		2.5-3.0 (HP Class)			F-90LI					
		4.0-6.0 (HP Class)			F-160LI					

NOTES:

- The nominal cooling capacity is the combined capacity of the Hitachi standard split system, and is based on the JIS standard B8616.

Cooling Operation Conditions	Heating Operation Conditions
Indoor Air Inlet Temperature: 27.0°C DB	Indoor Air Inlet Temperature: 20.0°C DB
19.0°C WB	Outdoor Air Inlet Temperature: 7.0°C DB)
Outdoor Air Inlet Temperature: 35.0°C DB	6.0°C WB
Piping Length:7.5 metre	Piping Length:7.5 metre
Piping Lift:0 metre	Piping Lift:0 metre
- The sound pressure level is based on following conditions. 1.5 metre Beneath the Unit. With Discharge Duct (2.0 metre) and Return Duct (1.0 metre). Voltage of the power source for the indoor fan motor is 220V. The above data was measured in an anechoic chamber so that reflected sound should be taken into consideration in the field.
- The data for external pressure (*3) indicates "Standard Pressure Setting (High Pressure Setting1 - High Pressure Setting2)" values when a filter is not used. The sound pressure level is based on the Standard Pressure Setting.

SET FREE Σ

DUCTED



HIGH ESP TYPE (EXTERNAL STATIC PRESSURE TYPE) [RPIH-HNAUNQ]



FEATURES AND BENEFITS



- High ESP (90/120Pa)
- Space saving design thanks to a height of only 300mm

Flexible installation options allow for multiple configurations

L-shaped space

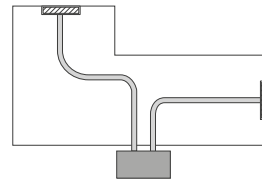

U-shaped space

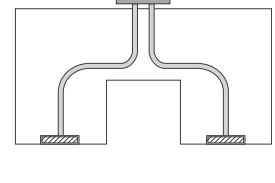

GENERAL DATA & ACCESSORIES

Model			RPIH-3.0HNAUNQ	RPIH-3.3HNAUNQ	RPIH-4.0HNAUNQ	RPIH-5.0HNAUNQ	RPIH-6.0HNAUNQ
Indoor Unit Power Supply			AC 1Φ, [220-240V/50Hz]				
Nominal Capacity	Cooling	kW	8.4	9.0	11.2	14.2	16.0
	Heating	kW	9.6	10.0	13.0	16.3	18.0
Sound Pressure Level	(Hi/Me/Lo)	dB(A)	42/39/34	42/39/34	43/39/34	44/41/37	48/42/37
Outer Dimension	H×W×D	mm	300×1,175×800	300×1,175×800	300×1,175×800	300×1,475×800	300×1,475×800
Net Weight		kg	45	45	45	53	54
Refrigerant			R410A	R410A	R410A	R410A	R410A
Indoor Fan Air Flow Rate	(Hi/Me/Lo)	m ³ /min	30/28/23	30/28/23	30/28/23	35.5/32/27	41/33/26
External Static Pressure (*3)		Pa	120(90)	120(90)	120(90)	120(90)	120(90)
Connections			Flare-Nut Connection (with Flare Nuts)				
Refrigerant Piping Diameter	Liquid Line	mm	Φ9.52	Φ9.52	Φ9.52	Φ9.52	Φ9.52
	Gas Line	mm	Φ15.88	Φ15.88	Φ15.88	Φ15.88	Φ15.88
Condensate Drain			VP25	VP25	VP25	VP25	VP25
Approximate Packing Volume		m ³	0.40	0.40	0.40	0.49	0.49

Receiver Kit		PC-ALHZ1
Condensate Drain Pump Kit		DUPI-361Q
Air filter	3.0-4.0 (HP class)	KW-PP9Q
	5.0-6.0 (HP class)	KW-PP10Q

NOTES:

- The cooling capacities above show the maximum capacities when the outdoor and indoor temperature are under the following conditions.

Cooling Operation Conditions		Heating Operation Conditions	
Indoor Air Inlet Temperature:	27.0°C DB	Indoor Air Inlet Temperature:	20.0°C DB
	19.0°C WB	Outdoor Air Inlet Temperature:	7.0°C DB
Outdoor Air Inlet Temperature:	35.0°C DB		6.0°C WB
Piping Length:	7.5 metre	Piping Length:	7.5 metre
Piping Lift:	0 metre	Piping Lift:	0 metre
- The sound pressure level is based on following conditions.
 - 1.4 metre Beneath the unit.
 - With Discharge Duct (2.0 metre) and Return Duct (1.0 metre).
 - Voltage of the power source for the indoor fan motor is 220V.
 - (In case of the power source of 240V, the sound pressure level increases by about 1~2dB(A).)
 - The above data was measured in an anechoic chamber so that reflected sound should be taken into consideration in the field.
- The data for external pressure (*3) indicates "Standard Pressure Setting values when a filter is not used.



COMPACT TYPE (AC MOTOR TYPE)



FEATURES AND BENEFITS



- Ideal for installation over the closet or windows thanks to the up to the compactness with 192mm height
- Drain-pump with 900mm lift as standard optional part
- Quiet operation level (as low as 20dB(A))
- Fan air flow rate up to 6 taps (DC motor model only)

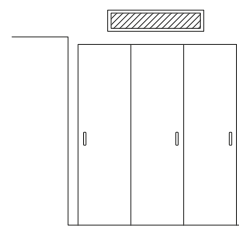

Over the closet

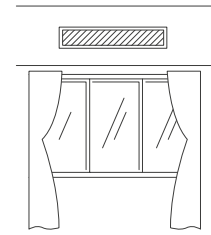

In dropped ceiling, over window

GENERAL DATA & ACCESSORIES

Model (AC MOTOR)			RPIZ-0.8HNATNQ	RPIZ-1.0HNATNQ	RPIZ-1.3HNATNQ	RPIZ-1.5HNATNQ	RPIZ-1.8HNATNQ	RPIZ-2.0HNATNQ	RPIZ-2.3HNATNQ	RPIZ-2.5HNATNQ
Indoor Unit Power Supply			AC 1Φ, [220-240V/50Hz]							
Nominal Capacity	Cooling	kW	2.2	2.8	3.6	4.0	5.0	5.6	6.3	7.1
	Heating	kW	2.5	3.2	4.0	4.5	5.6	6.3	7.1	8.0
Sound Pressure Level	(Hi/Me/Lo)	dB(A)	30/23/20	30/23/20	34/25/22	32.5/26/23	34/26/25	34/26/25	37/29/27	37/29/27
Outer Dimension	H×W×D	mm	192×700×447	192×700×447	192×700×447	192×910×447	192×1,180×447	192×1,180×447	192×1,180×447	192×1,180×447
Net Weight		kg	17	17	17	21	27	27	28	28
Refrigerant			R410A	R410A	R410A	R410A	R410A	R410A	R410A	R410A
Indoor Fan Air Flow Rate	(Hi/Me/Lo)	m ³ /min	9.5/6.5/5.5	9.5/6.5/5.5	9.5/6.5/5.5	10/7/6	15/10/9	15/10/9	17/10/9	17/10/9
External Static Pressure (*3)		Pa	10(30)	10(30)	10(30)	10(30)	10(30)	10(30)	10(30)	10(30)
Connections			Flare-Nut Connection (with Flare Nuts)							
Refrigerant Liquid Line		mm	Φ6.35	Φ6.35	Φ6.35	Φ6.35	Φ6.35	Φ6.35	Φ9.52	Φ9.52
Piping Diameter Gas Line		mm	Φ12.70	Φ12.70	Φ12.70	Φ12.70	Φ15.88	Φ15.88	Φ15.88	Φ15.88
Condensate Drain			VP25	VP25	VP25	VP25	VP25	VP25	VP25	VP25
Approximate Packing Volume		m ³	0.142	0.142	0.142	0.15	0.18	0.18	0.18	0.18

Receiver kit		PC-ALH31
Condensate Drain Pump Kit		-(included as standard equipment)
Air filter	0.8-1.5 (HP Class)	KW-PP5Q
	1.8-2.5 (HP Class)	KW-PP6Q

NOTES:

- The cooling capacities above show the maximum capacities when the outdoor and indoor temperature are under the following conditions.

Cooling Operation Conditions Indoor Air Inlet Temperature: 27.0°C DB 19.0°C WB Outdoor Air Inlet Temperature: 35.0°C DB Piping Length: 7.5 metre Piping Lift: 0 metre	Heating Operation Conditions Indoor Air Inlet Temperature: 20.0°C DB Outdoor Air Inlet Temperature: 7.0°C DB 6.0°C WB Piping Length: 7.5 metre Piping Lift: 0 metre
--	--
- The sound pressure level is based on following conditions.
 - 1.4 metre Beneath the unit.
 - With Discharge Duct (2.0 metre) and Return Duct (1.0 metre).
 - Voltage of the power source for the indoor fan motor is 220V.
 - (In case of the power source of 240V, the sound pressure level increases by about 1~2dB(A).)
 - The above data was measured in an anechoic chamber so that reflected sound should be taken into consideration in the field.
- The data for external pressure (*3) indicates "Standard Pressure Setting values when a filter is not used.

SET FREE Σ

DUCTED



COMPACT TYPE (DC MOTOR TYPE)



FEATURES AND BENEFITS



- Ideal for installation over the closet or windows thanks to the up to the compactness with 192mm height
- Drain-pump with 900mm lift as standard optional part
- Quiet operation level (as low as 22.5dB(A))
- Fan air flow rate up to 6 taps (DC motor model only)

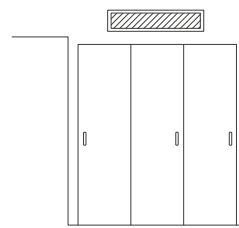

Over the closet

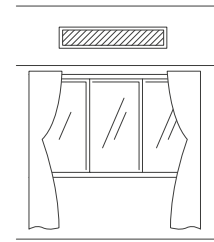

In dropped ceiling, over window

GENERAL DATA & ACCESSORIES

Model (DC MOTOR)			RPIZ-0.8HNDTSQ	RPIZ-1.0HNDTSQ	RPIZ-1.3HNDTSQ	RPIZ-1.5HNDTSQ	RPIZ-1.8HNDTSQ	RPIZ-2.0HNDTSQ	RPIZ-2.3HNDTSQ	RPIZ-2.5HNDTSQ
Indoor Unit Power Supply			AC 1Φ, [220-240V/50Hz] [220V/60Hz]							
Nominal Capacity	Cooling	kW	2.2	2.8	3.6	4.0	5.0	5.6	6.3	7.1
	Heating	kW	2.5	3.2	4.0	4.5	5.6	6.3	7.1	8.0
Sound Pressure Level	(6 taps)	dB(A)	33/31/28/ 25/23.5/22.5	33/31/28/ 25/23.5/22.5	33/31/28/ 25/23.5/22.5	31/30/28/ 25/22/20	36/33.5/31/ 28/24.5/22.5	36/33.5/31/ 28/24.5/22.5	36/33.5/31/ 28/24.5/22.5	36/33.5/31/ 28/24.5/22.5
Outer Dimension	H×W×D	mm	192×700×447	192×700×447	192×700×447	192×910×447	192×1,180×447	192×1,180×447	192×1,180×447	192×1,180×447
Net Weight		kg	17	17	17	20	24	24	24	24
Refrigerant			R410A	R410A	R410A	R410A	R410A	R410A	R410A	R410A
Indoor Fan Air Flow Rate	(6 taps)	m ³ /min	8.5/8/7/ 6/5.5/5	8.5/8/7/ 6/5.5/5	8.5/8/7/ 6/5.5/5	10/9/8/ 7.5/6.5/6	16.5/15/13/ 12/10/9	16.5/15/13/ 12/10/9	16.5/15/13/ 12/10/9	16.5/15/13/ 12/10/9
External Static Pressure (*3)		Pa	10(0-10-30)	10(0-10-30)	10(0-10-30)	10(0-10-30)	10(0-10-50)	10(0-10-50)	10(0-10-50)	10(0-10-50)
Connections			Flare-Nut Connection (with Flare Nuts)							
Refrigerant Piping Diameter	Liquid Line	mm	Φ6.35	Φ6.35	Φ6.35	Φ6.35	Φ6.35	Φ6.35	Φ9.52	Φ9.52
	Gas Line	mm	Φ12.70	Φ12.70	Φ12.70	Φ12.70	Φ15.88	Φ15.88	Φ15.88	Φ15.88
Condensate Drain			VP25	VP25	VP25	VP25	VP25	VP25	VP25	VP25
Approximate Packing Volume		m ³	0.142	0.142	0.142	0.15	0.18	0.18	0.18	0.18

Receiver kit	PC-ALHZ1
Condensate Drain Pump Kit	-(included as standard equipment)
Air filter	0.8-1.5 (HP Class) KW-PP5Q
	1.8-2.5 (HP Class) KW-PP6Q

NOTES:

1. The cooling capacities above show the maximum capacities when the outdoor and indoor temperature are under the following conditions.

Cooling Operation Conditions		Heating Operation Conditions	
Indoor Air Inlet Temperature:	27.0°C DB	Indoor Air Inlet Temperature:	20.0°C DB
	19.0°C WB	Outdoor Air Inlet Temperature:	7.0°C DB
Outdoor Air Inlet Temperature:	35.0°C DB		6.0°C WB
Piping Length:	7.5 metre	Piping Length:	7.5 metre
Piping Lift:	0 metre	Piping Lift:	0 metre

2. The sound pressure level is based on following conditions.

- 1.4 metre Beneath the unit.
- With Discharge Duct (2.0 metre) and Return Duct (1.0 metre).
- Voltage of the power source for the indoor fan motor is 220V.
- (In case of the power source of 240V, the sound pressure level increases by about 1~2dB(A).)
- The above data was measured in an anechoic chamber so that reflected sound should be taken into consideration in the field.

3. The data for external pressure (*3) indicates "Standard Pressure Setting values when a filter is not used.



LARGER AIR VOLUME TYPE



FEATURES AND BENEFITS



- Two external static pressure settings for better flexibility
- High external static pressure:
Up to 120Pa (140Pa in 7HP class)
- Suitable for air distribution for multiple zone

Flexible installation options allow for multiple configurations

L-shaped space

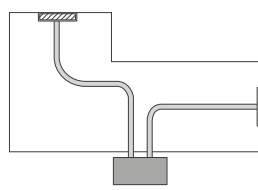

U-shaped space

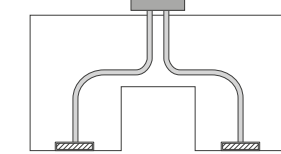

GENERAL DATA & ACCESSORIES

Model		RPI-3.0FSN2SQ	RPI-4.0FSN2SQ	RPI-5.0FSN2SQ	RPI-6.0FSN2SQ	RPI-7.0FSN2SQ
Indoor Unit Power Supply		AC 1 Φ, [220-240V/50Hz]				
Nominal Cooling Capacity	kW	8.0	11.2	14.0	16.0	18.0
Nominal Heating Capacity	kW	9.0	12.5	16.0	18.0	20.0
Sound Pressure Level (Overall A Scale) (Hi/Me/Lo)	High Pressure Setting	dB(A) 46/44/40	48/45/41	49/46/43	53/49/45	51/47/42
	Standard Pressure Setting	dB(A) 45/43/39	47/44/40	48/45/42	52/48/44	-
Outer Dimensions	H×W×D mm	350×1,076×800	350×1,076×800	350×1,300×800	350×1,300×800	440×1,430×550
Net Weight	kg	52	57	61	63	75
Refrigerant		R410A	R410A	R410A	R410A	R410A
Indoor Fan	High Pressure Setting	m ³ /min (l/s) 29/26/20 (483/433/333)	36/33/25 (600/550/417)	47/43/34 (783/717/567)	56/50/40 (933/833/667)	65/57/46 (1,083/950/767)
	Standard Pressure Setting	m ³ /min (l/s) 29/26/20 (483/433/333)	36/29/25 (600/483/417)	47/39/36 (783/650/600)	56/48/42 (933/800/700)	-
Air Flow Rate (Hi/Me/Lo)						
External Pressure (*1)	Pa	120 (70)	120 (70)	120 (70)	120 (70)	140
Motor Output	W	250	300	420	550	650
Connections		Flare-Nut Connection (with Flare Nuts)				
Refrigerant Piping	Liquid Line	mm Φ9.52	Φ9.52	Φ9.52	Φ9.52	Φ9.52
	Gas Line	mm Φ15.88	Φ15.88	Φ15.88	Φ15.88	Φ15.88
	Condensate Drain	VP25	VP25	VP25	VP25	VP25
Approximate Packing Measurement	m ³	0.49	0.49	0.57	0.57	0.54

Receiver kit PC-ALHZ1

NOTES:

1. The cooling and heating capacities above show the maximum capacities when the outdoor and indoor temperature are under the following conditions.

Cooling Operation Conditions

Indoor Air Inlet Temperature: 27.0°C DB
19.0°C WB
Outdoor Air Inlet Temperature: 35.0°C DB

Heating Operation Conditions

Indoor Air Inlet Temperature: 20.0°C DB
7.0°C DB
Outdoor Air Inlet Temperature: 6.0°C WB

Piping Length: 7.5 metre
Piping Lift: 0 metre

Piping Length: 7.5 metre
Piping Lift: 0 metre

2. The sound pressure level is based on following conditions. 1.5 metre Beneath the Unit. With Discharge Duct (2.0 metre) and Return Duct (1.0 metre). Voltage of the power source for the indoor fan motor is 220V. In case of the power source of 240V, the sound pressure level increases by about 1 or 2dB(A). The data in the table above was measured in an anechoic chamber so that reflected sound should be taken into consideration in the field.

3. The data for external pressure (*1) indicates "High Pressure Setting (Standard Pressure Setting)" values when a filter is not used. The sound pressure level is based on the Standard Pressure Setting.



WALL MOUNTED TYPE



FEATURES AND BENEFITS



Simple installation procedure

Refrigerant piping can be connected from the rear, base, or left of the unit, providing much greater flexibility for piping and selection of installation sites.



To ensure quieter environment

"External Expansion Valve Type" are suitable for hotel rooms or residences where background noise is lower. To minimise the continuous refrigerant running noise, You can install the expansion valve away from the unit.



Easy maintenance

Front flat panel keeps the unit from dust and facilitates maintenance work. The front grille hinges open easily—no tools are needed to gain quick access to the filter. The filter can be removed and cleaned as required.

GENERAL DATA & ACCESSORIES

Type Model	Expansion Valve built-in type								External Expansion Valve type				
	RPK-0.6 FSN4M	RPK-0.8 FSN4M	RPK-1.0 FSN4M	RPK-1.5 FSN4M	RPK-2.0 FSN4M	RPK-2.5 FSN4M	RPK-3.0 FSN4M	RPK-4.0 FSN4M	RPK-0.6 FSNH4M	RPK-0.8 FSNH4M	RPK-1.0 FSNH4M	RPK-1.5 FSNH4M	
Indoor Unit Power Supply	AC 1Φ, [220-240V/50Hz] [220V/60Hz]								AC 1Φ, [220-240V/50Hz] [220V/60Hz]				
Nominal Capacity	Cooling	1.7 2.2		2.8 4.0		5.6 7.1		8.0 11.2		1.7 2.2		2.8 4.0	
	Heating	1.9 2.5		3.2 4.8		6.3 8.5		9.0 12.5		1.9 2.5		3.2 4.8	
Sound Pressure Level	(Hi2/Hi/Me/Lo)	35/32/31/29	39/35/32/30	39/35/32/30	46/40/36/33	40/37/34/31	45/42/38/35	47/44/40/35	51/48/44/39	35/32/31/29	39/35/32/30	39/35/32/30	46/40/36/33
Colour		White								White			
Outer Dimension (H×W×D)	mm	300×790×230	300×790×230	300×790×230	300×900×230	300×1,100×260	300×1,100×260	300×1,100×260	300×1,100×260	300×790×230	300×790×230	300×790×230	300×900×230
Net Weight	kg	10	10	10	11	14.5	15	15	15	10	10	10	11
Refrigerant		R410A	R410A	R410A	R410A	R410A	R410A	R410A	R410A	R410A	R410A	R410A	R410A
Indoor Fan Air Flow Rate	(Hi2/Hi/Me/Lo)	8/7.5/7/6	10/8/7/6.5	10/8/7/6.5	14/11/9/7.5	14.5/13/11/9.5	18.5/16.5/14/12	20/17.5/15.5/12.5	23/20/17.5/14.5	8/7.5/7/6	10/8/7/6.5	10/8/7/6.5	14/11/9/7.5
	Motor	38	38	38	38	38	38	38	38	38	38	38	38
Connections		Flare-Nut Connection (with Flare Nuts)								Flare-Nut Connection (with Flare Nuts)			
Refrigerant Piping Diameter	Liquid Line	Φ6.35	Φ6.35	Φ6.35	Φ6.35	Φ6.35	Φ9.52	Φ9.52	Φ9.52	Φ6.35	Φ6.35	Φ6.35	Φ6.35
	Gas Line	Φ12.7	Φ12.7	Φ12.7	Φ12.7	Φ12.7	Φ15.88	Φ15.88	Φ15.88	Φ12.7	Φ12.7	Φ12.7	Φ12.7
Condensate Drain		VP16	VP16	VP16	VP16	VP16	VP16	VP16	VP16	VP16	VP16	VP16	VP16
Approximate Packing Volume	m ³	0.09	0.09	0.09	0.11	0.14	0.14	0.14	0.14	0.09	0.09	0.09	0.11
Accessory included		Wall Mounting Bracket								Wall Mounting Bracket			

Receiver kit	PC-ALH31
Strainer kit	MSF-NP63A1
External Expansion Valve Kit	EV-1.5N1

NOTES:

- The cooling and heating capacities above show the maximum capacities when the outdoor and indoor temperature are under the following conditions.

Cooling Operation Conditions		Heating Operation Conditions	
Indoor Air Inlet Temperature:	27.0°C DB	Indoor Air Inlet Temperature:	20.0°C DB
	19.0°C WB	Outdoor Air Inlet Temperature:	7.0°C DB
Outdoor Air Inlet Temperature:	35.0°C DB		6.0°C WB
Piping Length: 7.5 metre		Piping Length: 7.5 metre	
Piping Lift: 0 metre		Piping Lift: 0 metre	
- The sound pressure level is based on following conditions.
 - 1.0 metre Beneath the Unit.
 - 1.0 metre from Discharge Grille.

The above data was measured in an anechoic chamber so that reflected sound should be taken into consideration in the field. When bottom air inlet is adopted, sound pressure will increase according to factors such as installation mode and the room structure.

STRAINER KIT

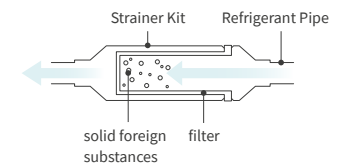

A strainer kit ensures that solid foreign substances, like small particles of metal, are caught before they enter the electric expansion valves of a wall-mounted indoor unit. Without the strainer kit's filter, these particles may prevent the valves from being fully sealed, creating a risk of explosive condensation when the unit becomes active.



FLOOR/CEILING CONVERTIBLE TYPE



FEATURES AND BENEFITS



Adapts to both floor and ceiling

[CEILING USE]

Supplies air to a wide area.
High ceiling use capability.

[FLOOR USE]

Smaller footprint: Only 230mm in depth.
Suitable for installation beneath a window thanks to the 680mm height.



New air-intake design

Equipped with air-intakes, the unit connects with ventilations such as a Total Heat Exchanger using a duct, providing better interior air quality.

GENERAL DATA & ACCESSORIES

Model			RPFC-1.8FSNQ	RPFC-2.0FSNQ	RPFC-2.3FSNQ	RPFC-2.5FSNQ	RPFC-3.0FSNQ	RPFC-3.3FSNQ	RPFC-4.0FSNQ	RPFC-5.0FSNQ
Indoor Unit Power Supply			AC 1Φ, [220-240V/50Hz] [220V/60Hz]							
Nominal Capacity	Cooling	kW	5.0	5.6	6.3	7.1	8.4	9.0	11.2	14.2
	Heating	kW	5.6	6.5	7.5	8.5	9.6	10.0	13.0	16.3
Sound Pressure Level	Ceiling Mode	dB(A)	39/35/30	39/35/30	45/41/37	45/41/37	43/39/34	45/40/36	51/46/40	50/46/42
	Floor Mode	dB(A)	43/38/35	43/38/35	48/44/40	48/44/40	46/41/37	48/43/39	54/49/43	55/50/46
Outer Dimension	(H×W×D)	mm	230×990×680	230×990×680	230×990×680	230×990×680	230×1,285×680	230×1,285×680	230×1,285×680	230×1,580×680
Net Weight		kg	31	31	32	32	39	40	41	47
Refrigerant			R410A	R410A	R410A	R410A	R410A	R410A	R410A	R410A
Indoor Fan Air Flow Rate	(Hi/Me/Lo)	m ³ /h	780/660/540	780/660/540	966/840/678	966/840/678	1,092/912/732	1,164/978/798	1,488/1,230/978	1,980/1,680/1,380
Connections			Flare-Nut Connection (with Flare Nuts)							
Refrigerant Piping Diameter	Liquid Line	mm	Φ6.35	Φ6.35	Φ9.52	Φ9.52	Φ9.52	Φ9.52	Φ9.52	Φ9.52
	Gas Line	mm	Φ15.88	Φ15.88	Φ15.88	Φ15.88	Φ15.88	Φ15.88	Φ15.88	Φ15.88
Condensate Drain			VP25	VP25	VP25	VP25	VP25	VP25	VP25	VP25
Approximate Packing Volume		m ³	0.31	0.31	0.31	0.31	0.40	0.40	0.40	0.48

Receiver kit **PC-ALHZ1**

NOTES:

1. The cooling and heating capacities above show the maximum capacities when the outdoor and indoor temperature are under the following conditions.

Cooling Operation Conditions		Heating Operation Conditions	
Indoor Air Inlet Temperature:	27.0°C DB	Indoor Air Inlet Temperature:	20.0°C DB
	19.0°C WB	Outdoor Air Inlet Temperature:	7.0°C DB
Outdoor Air Inlet Temperature:	35.0°C DB		6.0°C WB
Piping Length: 7.5 metre		Piping Length: 7.5 metre	
Piping Lift: 0 metre		Piping Lift: 0 metre	

2. The sound pressure level is based on following conditions.

- 1.0 metre Beneath the unit.
 - 1.0 metre from Discharge grille.
- The above data was measured in an anechoic chamber so that reflected sound should be taken into consideration in the field.
When bottom air inlet is adopted, sound pressure will increase according to factors such as installation mode and the room structure.



CEILING SUSPENDED TYPE



FEATURES AND BENEFITS

Adaptability



1) Wide Detection area of motion sensor (SOR-NEP)

(Optional part) to achieve better energy-saving



2) Auto louvre

Soften the discomfort by temperature irregularity and cold draft

Design Flexibility



Suitable for high ceiling space

Thanks to 5.6m cooling air blow down

GENERAL DATA & ACCESSORIES

Model			RPC-1.5FSN3	RPC-2.0FSN3	RPC-2.5FSN3	RPC-3.0FSN3	RPC-4.0FSN3	RPC-5.0FSN3	RPC-6.0FSN3
Indoor Unit Power Supply			AC 1Φ, [220-240V/50Hz] [220V/60Hz]						
Nominal Capacity	Cooling	kW	4.0	5.6	7.1	8.0	11.2	14.0	16.0
	Heating	kW	4.8	6.3	8.5	9.0	12.5	16.0	18.0
Sound Pressure Level	(Hi2/Hi/Me/Lo)	dB(A)	37/35/31/28	38/35/31/28	38/35/31/28	40/37/33/29	44/42/37/32	48/45/41/35	49/47/42/36
Colour			Neutral White						
Outer Dimension	(H×W×D)	mm	235×960×690	235×960×690	235×1,270×690	235×1,270×690	235×1,580×690	235×1,580×690	235×1,580×690
Net Weight		kg	26	27	35	35	41	41	41
Refrigerant			R410A						
Indoor Fan Air Flow Rate	(Hi2/Hi/Me/Lo)	m ³ /min	15/13/11/9	15/13/11/9	19/16.5/14/11.5	21/18.5/15.5/12.5	30/26.5/22/17	35/31/25.5/20	37/32.5/27/21
Connections			Flare-Nut Connection (with Flare Nuts)						
Refrigerant Piping Diameter	Liquid Line	mm	Φ6.35	Φ6.35	Φ9.52	Φ9.52	Φ9.52	Φ9.52	Φ9.52
	Gas Line	mm	Φ12.7	Φ15.88	Φ15.88	Φ15.88	Φ15.88	Φ15.88	Φ15.88
Condensate Drain			VP20						
Approximate Packing Volume		m ³	0.23	0.23	0.31	0.31	0.38	0.38	0.38
Receiver kit			PC-ALHP1						
Motion Sensor			SOR-NEP						
Condensate Drain Pump Kit			1.5 (HP Class)		DUPC-63K1				
			2.0 (HP Class)		DUPC-71K1				
			2.5-6.0 (HP Class)		DUPC-160K1				

NOTES:

1. The cooling and heating capacities above show the maximum capacities when the outdoor and indoor temperature are under the following conditions.

Cooling Operation Conditions

Indoor Air Inlet Temperature: 27.0°C DB

19.0°C WB

Outdoor Air Inlet Temperature: 35.0°C DB

Piping Length: 7.5 metre

Piping Lift: 0 metre

Heating Operation Conditions

Indoor Air Inlet Temperature: 20.0°C DB

Outdoor Air Inlet Temperature: 7.0°C DB

6.0°C WB

Piping Length: 7.5 metre

Piping Lift: 0 metre

2. The sound pressure level is based on following conditions.

1.0 metre Beneath the unit.

1.0 metre from Discharge grille.

The above data was measured in an anechoic chamber so that reflected sound should be taken into consideration in the field.

When bottom air inlet is adopted, sound pressure will increase according to factors such as installation mode and the room structure.



FLOOR EXPOSED TYPE



FEATURES AND BENEFITS



Design Flexibility

Floor Exposed units can be installed with a minimum of disruption to walls and floors, making them an excellent retrofitting option. The 220mm depth means that little installation space is required. With a total height of up to 630mm, they are well suited to installation beneath a window.

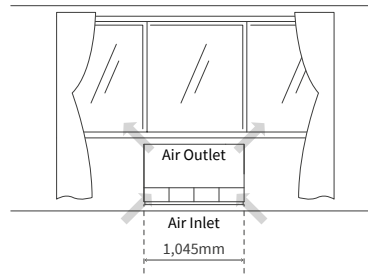

GENERAL DATA & ACCESSORIES

Model		RPF-1.0FSN2E	RPF-1.5FSN2E	RPF-2.0FSN2E	RPF-2.5FSN2E
Indoor Unit Power Supply		Current AC 1 Phase			
		[220-240V/50Hz] [220V/60Hz]			
Nominal Capacity	Cooling	kW 2.8	4.0	5.6	7.1
	Heating	kW 3.2	4.8	6.3	8.5
Sound Pressure Level	(Hi/Me/Lo)	dB(A) 35/32/29	38/35/31	39/36/32	42/38/34
Colour		Spring White			
Outer Dimension (H×W×D)		mm 630×1,045×220	630×1,170×220	630×1,420×220	630×1,420×220
Net Weight		kg 25	28	33	34
Refrigerant		R410A			
Indoor Fan Air Flow Rate	(Hi/Me/Lo)	m ³ /min 8.5/7/6	12/10/09	16/14/11	16/14/11
Motor		W 20	28	45	45
Connections		Flare-Nut Connection (with Flare Nuts)			
Refrigerant Piping	Liquid Line	mm Φ6.35	Φ6.35	Φ6.35	Φ9.52
	Gas Line	mm Φ12.70	Φ12.70	Φ15.88	Φ15.88
Condensate Drain		Φ18.5 OD			
Packaging Volume		m ³ 0.22	0.24	0.29	0.29

Receiver kit PC-ALHZ1

NOTES:

1. The cooling and heating capacities above show the maximum capacities when the outdoor and indoor temperature are under the following conditions.

Cooling Operation Conditions

Indoor Air Inlet Temperature: 27.0°C DB
19.0°C WB
Outdoor Air Inlet Temperature: 35.0°C DB

Piping Length: 7.5 metre
Piping Lift: 0 metre

Heating Operation Conditions

Indoor Air Inlet Temperature: 20.0°C DB
Outdoor Air Inlet Temperature: 7.0°C DB
6.0°C WB

Piping Length: 7.5 metre
Piping Lift: 0 metre

2. The sound pressure level is based on following conditions.

1.0 metre from the unit.
1.0 metre from floor level.

Voltage of the power source for the indoor fan motor is 220V.
The above data was measured in an anechoic chamber.

SET FREE Σ

CONCEALED & EXPOSED



FLOOR CONCEALED TYPE



FEATURES AND BENEFITS



Design Flexibility

Blends unobtrusively with any interior décor: only the suction and discharge grilles are visible.

Its low height (only 620mm) enables the unit to fit perfectly beneath a window.

Requires little installation space thanks to its slim 202mm depth.

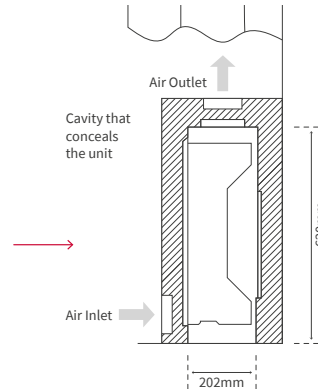
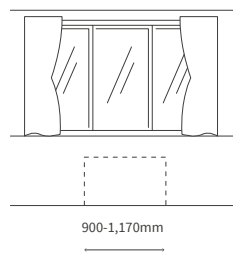

GENERAL DATA & ACCESSORIES

Model		RPFI-1.0FSN2E	RPFI-1.5FSN2E	RPFI-2.0FSN2E	RPFI-2.5FSN2E	
Indoor Unit Power Supply		Current AC 1 Phase				
		[220-240V/50Hz] [220V/60Hz]				
Nominal Capacity	Cooling	kW	2.8	4.0	5.6	7.1
	Heating	kW	3.2	4.8	6.3	8.5
Sound Pressure Level	(Hi/Me/Lo)	dB(A)	35/32/29	38/35/31	39/36/32	42/38/34
Outer Dimension	(H×W×D)	mm	620×848×220	620×973×220	620×1,223×220	620×1,223×220
Net Weight		kg	19	23	27	28
Refrigerant			R410A	R410A	R410A	R410A
Indoor Fan Air Flow Rate	(Hi/Me/Lo)	m ³ /min	8.5/7/6	12/10/09	16/14/11	16/14/11
Motor		W	20	28	45	45
Connections		Flare-Nut Connection (with Flare Nuts)				
Refrigerant Piping	Liquid Line	mm	Φ6.35	Φ6.35	Φ6.35	Φ9.52
	Gas Line	mm	Φ12.70	Φ12.70	Φ15.88	Φ15.88
Condensate Drain			VP25	VP25	VP25	VP25
Packaging Volume		m ³	0.22	0.23	0.25	0.25

Receiver kit **PC-ALHZ1**

NOTES:

1. The cooling and heating capacities above show the maximum capacities when the outdoor and indoor temperature are under the following conditions.

Cooling Operation Conditions

Indoor Air Inlet Temperature: 27.0°C DB

19.0°C WB

Outdoor Air Inlet Temperature: 35.0°C DB

Piping Length: 7.5 metre

Piping Lift: 0 metre

Heating Operation Conditions

Indoor Air Inlet Temperature: 20.0°C DB

7.0°C DB

Outdoor Air Inlet Temperature: 6.0°C WB

Piping Length: 7.5 metre

Piping Lift: 0 metre

2. The sound pressure level is based on following conditions.

1.0 metre from the unit.

1.0 metre from floor level.

Voltage of the power source for the indoor fan motor is 220V.

The above data was measured in an anechoic chamber.



4-WAY CASSETTE TYPE [RCI-FSN3]



FEATURES AND BENEFITS

★ Adaptability

- 1) Wide Detection area of motion sensor
- 2) Control air flow with individual four-way louvers

♡ Comfort

- Setback temperature control available, leading to better operation.
- GentleCool control to ensure you are not bothered by cold draft

✏ Design Flexibility

- 1) Used in both narrow ceiling cavity, and with high ceiling
- 2) Standard drain pump with 850mm lift
- 3) Round ducts can be attached directly
- 4) The height of the space for installing the unit can be fine-tuned

GENERAL DATA & ACCESSORIES

Model			RCI-1.0FSN3	RCI-1.5FSN3	RCI-2.0FSN3	RCI-2.5FSN3	RCI-3.0FSN3	RCI-4.0FSN3	RCI-5.0FSN3	RCI-6.0FSN3
Indoor Unit Power Supply			AC 1Φ, [220-240V/50Hz] [220V/60Hz]							
Nominal Capacity	Cooling	kW	2.8	4.0	5.6	7.1	8.0	11.2	14.0	16.0
	Heating	kW	3.2	4.8	6.3	8.5	9.0	12.5	16.0	18.0
Sound Pressure Level	(Hi2/Hi/Me/Lo)	dB(A)	33/30/28/27	35/31/30/27	37/32/30/27	42/36/32/28	42/36/32/28	48/43/39/33	48/45/40/35	48/46/41/37
Outer Dimension (H×W×D)		mm	248×840×840	248×840×840	248×840×840	248×840×840	298×840×840	298×840×840	298×840×840	298×840×840
Net Weight		kg	20	21	21	22	26	26	26	26
Refrigerant			R410A	R410A	R410A	R410A	R410A	R410A	R410A	R410A
Indoor Fan Air Flow Rate	(Hi2/Hi/Me/Lo)	m ³ /min	15/13/11/9	21/17/14/11	22/17/14/11	27/23/18/14	27/23/18/14	37/31/24/20	37/33/26/21	37/35/28/22
Connections			Flare-Nut Connection (with flare Nuts)							
Refrigerant Piping Diameter	Liquid Line	mm	Φ6.35	Φ6.35	Φ6.35	Φ9.52	Φ9.52	Φ9.52	Φ9.52	Φ9.52
	Gas Line	mm	Φ12.7	Φ12.7	Φ15.88	Φ15.88	Φ15.88	Φ15.88	Φ15.88	Φ15.88
Condensate Drain			VP25							
Approximate Packing Volume		m ³	0.21	0.21	0.21	0.21	0.25	0.25	0.25	0.25

Adaptable Panel Model		P-AP160NA1 (without Motion Sensor)	P-AP160NAE (with Motion Sensor)
Colour		Neutral White	
Outer Dimension (H×W×D)	mm	37×950×950	
Net Weight	kg	6.5	
Approximate Packing Volume	m ³	0.10	

Decoration panel	With Motion Sensor	P-AP160NAE	3-Way Outlet Parts Set	PI-160LS1
	Without Motion Sensor	P-AP160NA1	T-Pipe Connection Kit	TKCI-160K
Receiver kit		PC-ALH3	Kit for Deodorant Filter & Filter set	1.0-2.5 (HP Class) F-71L-D1 3.0-6.0 (HP Class) F-160L-D1
Duct Adapter		PD-75A	Kit for Deodorant Filter & Filter Box	B-160H2
Fresh Air Intake Kit		OACI-160K2	Antibacterial Long-life Filter	F-160L-K

NOTES:

1. The cooling and heating capacities above show the maximum capacities when the outdoor and indoor temperature are under the following conditions.

Cooling Operation Conditions		Heating Operation Conditions	
Indoor Air Inlet Temperature:	27.0°C DB	Indoor Air Inlet Temperature:	20.0°C DB
	19.0°C WB	Outdoor Air Inlet Temperature:	7.0°C DB
Outdoor Air Inlet Temperature:	35.0°C DB		6.0°C WB
Piping Length:	7.5 metre	Piping Length:	7.5 metre
Piping Lift:	0 metre	Piping Lift:	0 metre

2. The sound pressure level is based on following conditions.

- 1.5 metre Beneath the unit.
- The data in the table above was measured in an anechoic chamber so that reflected sound should be taken into consideration in the field.

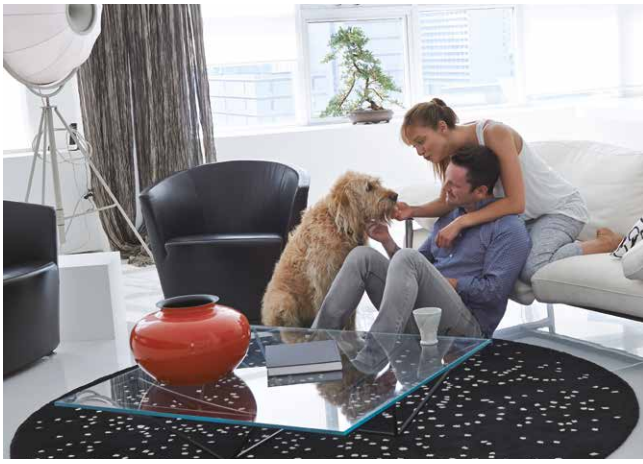

4-WAY CASSETTE TYPE [RCI-FSKDNQ]



FEATURES AND BENEFITS

Adaptability



1) Wide Detection area of motion sensor (PS-MSK2)

(Optional part) to achieve better energy-saving



2) Control air flow with individual four air direction

More comfortable air conditioning can be achieved along each zone requirement

Design Flexibility



Suitable for high ceiling space

Thanks to cooling air blow up to 5.5m down

GENERAL DATA & ACCESSORIES

Model			RCI-1.0FSKDNQ	RCI-1.5FSKDNQ	RCI-2.0FSKDNQ	RCI-2.5FSKDNQ	RCI-3.0FSKDNQ	RCI-4.0FSKDNQ	RCI-5.0FSKDNQ	RCI-6.0FSKDNQ
Indoor Unit Power Supply			AC 1Φ, [220-240V/50Hz] [220V/60Hz]							
Nominal Capacity	Cooling	kW	2.8	4.0	5.6	7.1	8.0	11.2	14.0	16.0
	Heating	kW	3.2	4.8	6.3	8.5	9.0	12.5	16.0	18.0
Sound Pressure Level	(Hi2/Hi/Me/Lo)	dB(A)	33/30/28/27	35/31/30/27	37/32/30/27	42/36/32/28	42/36/32/28	48/43/39/33	48/45/40/35	48/46/41/37
Outer Dimension	(H×W×D)	mm	238×840×840	238×840×840	238×840×840	238×840×840	288×840×840	288×840×840	288×840×840	288×840×840
Net Weight		kg	20	21	21	22	26	26	26	26
Refrigerant			R410A	R410A	R410A	R410A	R410A	R410A	R410A	R410A
Indoor Fan Air Flow Rate	(Hi2/Hi/Me/Lo)	m ³ /min	15/13/11/9	21/17/14/11	22/17/14/11	27/23/18/14	27/23/18/14	37/31/24/20	37/33/26/21	37/35/28/22
Connections			Flare-Nut Connection (with flare Nuts)							
Refrigerant	Liquid Line	mm	Φ6.35	Φ6.35	Φ6.35	Φ9.52	Φ9.52	Φ9.52	Φ9.52	Φ9.52
Piping Diameter	Gas Line	mm	Φ12.7	Φ12.7	Φ12.7	Φ15.88	Φ15.88	Φ15.88	Φ15.88	Φ15.88
Condensate Drain			VP25	VP25	VP25	VP25	VP25	VP25	VP25	VP25
Approximate Packing Volume		m ³	0.21	0.21	0.21	0.21	0.25	0.25	0.25	0.25

Adaptable Panel Model	Included (without Motion Sensor)
Colour	Neutral White
Outer Dimension (H×W×D)	mm 40×950×950
Net Weight	kg 6.5
Approximate Packing Volume	m ³ 0.10

Decoration Panel	- (Standard)
Receiver Kit	PC-ALH3
Motion Sensor	PS-MSK2
Condensate Drain Pump	- (Standard)

NOTE:

1. The cooling and heating capacities above show the maximum capacities when the outdoor and indoor temperature are under the following conditions.

Cooling Operation Conditions

Indoor Air Inlet Temperature: 27.0°C DB (80.0°F DB)
19.0°C WB (66.2°F WB)
Outdoor Air Inlet Temperature: 35.0°C DB (95.0°F DB)

Piping Length: 7.5 metre
Piping Lift: 0 metre

Heating Operation Conditions

Indoor Air Inlet Temperature: 20.0°C DB (68.0°F DB)
7.0°C DB (45.0°F DB)
Outdoor Air Inlet Temperature: 6.0°C WB (43.0°F WB)

Piping Length: 7.5 metre
Piping Lift: 0 metre

2. The sound pressure level is based on following conditions.

1.5 metre Beneath the unit.

The data in the table above was measured in an anechoic chamber so that reflected sound should be taken into consideration in the field.

3. Decoration panel is included.



4-WAY CASSETTE COMPACT TYPE



FEATURES AND BENEFITS

Adaptability



1) Wide Detection area of motion sensor (SOR-NEC)

(Optional part) to achieve better energy-saving



2) Top-class silent operation

As quiet as gentle breeze

Design Flexibility



Compact

Adaptation to 600×600mm ceilings

GENERAL DATA & ACCESSORIES

Model			RCIM-0.6FSN4	RCIM-0.8FSN4	RCIM-1.0FSN4	RCIM-1.5FSN4	RCIM-2.0FSN4	RCIM-2.5FSN4
Indoor Unit Power Supply			AC 1Φ, [230V/50Hz] [220-240V/50Hz] [220V/60Hz]					
Nominal Capacity	Cooling	kW	1.6	2.2	2.8	4.0	5.6	7.1
	Heating	kW	1.9	2.5	3.2	4.8	6.3	8.5
Sound Pressure Level	(Hi2/Hi/Me/Lo)	dB(A)	34/30/28/24.5	36/33/29/24.5	38/34/30/24.5	41/37/33/27.5	45/39/35/31	47/43/39/35
Outer Dimension	(H×W×D)	mm	285×570×570					
Net Weight		kg	16	16	16	16	17	17
Refrigerant			R410A					
Indoor Fan Air Flow Rate	(Hi2/Hi/Me/Lo)	m ³ /min	10/8.5/7.5/6	11/9.5/8/6	12/10/8.5/6	13/11/9.5/7	15/12/10/8	16/14/12/10
Connections			Flare-Nut Connection (with Flare Nuts)					
Refrigerant	Liquid Line	mm	Φ6.35					
Piping Diameter	Gas Line	mm	Φ12.7					
Condensate Drain			VP25					
Approximate Packing Volume		m ³	0.13					

Adaptable Panel Model		P-AP56NAM (without Motion Sensor)
Colour		Neutral White
Outer Dimension (H×W×D)	mm	30×620×620
Net Weight	kg	3.0
Approximate Packing Volume	m ³	0.04

Decoration panel	P-AP56NAM
Motion Sensor	SOR-NEC
Receiver kit	PC-ALHC1
Duct Adapter	PD-75C

NOTES:

1. The cooling and heating capacities above show the maximum capacities when the outdoor and indoor temperature are under the following conditions.

Cooling Operation Conditions

Indoor Air Inlet Temperature: 27.0°C DB
19.0°C WB

Outdoor Air Inlet Temperature: 35.0°C DB

Piping Length: 7.5 metre

Piping Lift: 0 metre

Heating Operation Conditions

Indoor Air Inlet Temperature: 20.0°C DB

Outdoor Air Inlet Temperature: 7.0°C DB

6.0°C WB

Piping Length: 7.5 metre

Piping Lift: 0 metre

2. The sound pressure level is based on following conditions.

1.5 metre Beneath the unit.

The data in the table above was measured in an anechoic chamber so that reflected sound should be taken into consideration in the field.

3. RCIM-0.6FSN4 cannot be connected to HNRQ series.

Please refer to the technical catalogue for the details.



2-WAY CASSETTE TYPE



FEATURES AND BENEFITS

★ Adaptability

- 1) Wide Detection area of motion sensor (SOR-NED)
(Optional part) to achieve better energy-saving
- 2) Control air flow with individual four air direction

♡ Comfort

- Setback temperature control available, leading to better operation.
- GentleCool control to ensure you are not bothered by cold draft

✏ Design Flexibility

- Suitable for high ceiling space.
Thanks to 4.6m cooling air blow down.

GENERAL DATA & ACCESSORIES

Model		RCD-0.8FSN3	RCD-1.0FSN3	RCD-1.5FSN3	RCD-2.0FSN3	RCD-2.5FSN3	RCD-3.0FSN3	RCD-4.0FSN3	RCD-5.0FSN3	RCD-6.0FSN3	
Indoor Unit Power Supply		AC 1Φ, [220-240V/50Hz] [220V/60Hz]									
Nominal Capacity	Cooling	kW	2.2	2.8	4.0	5.6	7.1	8.0	11.2	14.0	16.0
	Heating	kW	2.5	3.2	4.8	6.3	8.5	9.0	12.5	16.0	18.0
Sound Pressure Level	(Hi2/Hi/Me/Lo)	dB(A)	30/29/28/27	31/29/28/27	37/34/31/30	39/36/33/30	42/39/36/33	45/42/38/33	43/40/37/34	47/44/41/35	48/45/42/39
Outer Dimension (H×W×D)		mm	298×860×630	298×860×630	298×860×630	298×860×630	298×860×630	298×860×630	298×1,420×630	298×1,420×630	298×1,420×630
Net Weight		kg	23	23	25	25	25	25	39	39	39
Refrigerant			R410A	R410A	R410A	R410A	R410A	R410A	R410A	R410A	R410A
Indoor Fan Air Flow Rate	(Hi2/Hi/Me/Lo)	m ³ /min	10/9/7.5/6.5	11/9.5/8.5/7	15/13/11.5/10	16.5/14.5/12.5/10.5	18.5/16.5/14.5/12.5	21/18.5/16/12.5	30/26.5/23/20	35/31/27/21	37/32.5/28.5/24
Connections			Flare-Nut Connection (with Flare Nuts)								
Refrigerant Piping Diameter	Liquid Line	mm	Φ6.35	Φ6.35	Φ6.35	Φ6.35	Φ9.52	Φ9.52	Φ9.52	Φ9.52	Φ9.52
	Gas Line	mm	Φ12.7	Φ12.7	Φ12.7	Φ12.7	Φ15.88	Φ15.88	Φ15.88	Φ15.88	Φ15.88
Condensate Drain			VP25	VP25	VP25	VP25	VP25	VP25	VP25	VP25	VP25
Approximate Packing Volume		m ³	0.24	0.24	0.24	0.24	0.24	0.24	0.36	0.36	0.36

Adaptable Panel Model		P-AP90DNA (for RCD-[0.8-3.0]FSN3)	P-AP160DNA (for RCD-[4.0-6.0]FSN3)
Colour		Neutral White	Neutral White
Outer Dimension (H×W×D)		30×1,100×710	30×1,660×710
Net Weight		7.5	10.5
Approximate Packing Volume		0.13	0.20

Decoration panel	0.8-3.0 (HP Class)	P-AP90DNA	Antibacterial Long-life Filter	0.8-3.0 (HP Class)	F-90MD-K1
	4.0-6.0 (HP Class)	P-AP160DNA		4.0-6.0 (HP Class)	F-160MD-K1
Receiver kit		PC-ALHD1		0.8-3.0 (HP Class)	B-90HD
Motion Sensor		SOR-NED	Filter Box	4.0-6.0 (HP Class)	B-160HD
Duct Adapter		PD-150D			

NOTES:

1. The cooling and heating capacities above show the maximum capacities when the outdoor and indoor temperature are under the following conditions.

Cooling Operation Conditions		Heating Operation Conditions	
Indoor Air Inlet Temperature:	27.0°C DB	Indoor Air Inlet Temperature:	20.0°C DB
	19.0°C WB	Outdoor Air Inlet Temperature:	7.0°C DB
Outdoor Air Inlet Temperature:	35.0°C DB		6.0°C WB
Piping Length:7.5 metre		Piping Length:7.5 metre	
Piping Lift:0 metre		Piping Lift:0 metre	

2. The sound pressure level is based on following conditions.

1.5 metre Beneath the unit.
The data in the table above was measured in an anechoic chamber so that reflected sound should be taken into consideration in the field.



1-WAY CASSETTE TYPE



FEATURES AND BENEFITS

Adaptability



1) Wide Detection area of motion sensor (SOR-NES)

(Optional part) to achieve better energy-saving



2) Quiet operation

New design in fan inlet and fan resulted in the low sound pressure

Design Flexibility



3 installation types selectable

Corner type (standard)
Clipped ceiling (one-way) type
Clipped ceiling (two-way) type

GENERAL DATA & ACCESSORIES

Model			RCS-0.8FSN	RCS-1.0FSN	RCS-1.5FSN	RCS-2.0FSN	RCS-2.5FSN	RCS-3.0FSN
Indoor Unit Power Supply			AC 1Φ, [220-240V/50Hz] [230V/50Hz] [220V/60Hz]					
Nominal Capacity	Cooling	kW	2.2	2.8	4.0	5.6	7.1	8.0
	Heating	kW	2.5	3.2	4.8	6.3	8.5	9.0
Sound Pressure Level	(Hi2/Hi/Me/Lo)	dB(A)	34/32/29/27	36/34/31/28	40/37/33/31	42/38/35/31	43/39/36/32	43/40/37/33
Outer Dimension	(H×W×D)	mm	235×900×710	235×900×710	235×900×710	235×900×710	235×1,210×710	235×1,210×710
Net Weight		kg	25	25	26	26	33	33
Refrigerant			R410A	R410A	R410A	R410A	R410A	R410A
Indoor Fan Air Flow Rate	(Hi2/Hi/Me/Lo)	m ³ /min	8.5/7.5/6.5/6	9.5/8.5/7.5/6.5	13/11.5/10/8.5	14.5/13/11/9.5	18.5/16.5/14.5/12.5	20/17.5/15.5/13
Connections			Flare-Nut Connection (with Flare Nuts)					
Refrigerant Piping Diameter	Liquid Line	mm	Φ6.35	Φ6.35	Φ6.35	Φ6.35	Φ9.52	Φ9.52
	Gas Line	mm	Φ12.7	Φ12.7	Φ12.7	Φ12.7	Φ15.88	Φ15.88
Condensate Drain			VP25	VP25	VP25	VP25	VP25	VP25
Approximate Packing Volume		m ³	0.25	0.25	0.25	0.25	0.32	0.32

Adaptable Panel Model		P-AP36CNA (for RCS-[0.8-1.0]FSN)	P-AP56CNA (for RCS-[1.5-2.0]FSN)	P-AP80CNA (for RCS-[2.5-3.0]FSN)
Colour		Neutral White		Neutral White
Outer Dimension (H×W×D)	mm	35×1,100×800	35×1,100×800	35×1,410×800
Net Weight	kg	4.5	4.5	6.0
Approximate Packing Volume	m ³	0.098	0.098	0.125

Decoration panel	0.8-1.0 (HP Class)	P-AP36CNQ	Grille for Front Discharge	0.8-2.0 (HP Class)	DG-56SW1
	1.5-2.0 (HP Class)	P-AP56CNA		2.5-3.0 (HP Class)	DG-80SW1
	2.5-3.0 (HP Class)	P-AP80CNA		0.8-2.0 (HP Class)	PIS-56LS
Receiver kit		PC-ALHS1	Air Outlet Shutter Plate	2.5-3.0 (HP Class)	PIS-80LS
Motion Sensor		SOR-NES			
Duct Adapter		PD-100			

NOTES:

1. The cooling and heating capacities above show the maximum capacities when the outdoor and indoor temperature are under the following conditions.

Cooling Operation Conditions		Heating Operation Conditions	
Indoor Air Inlet Temperature:	27.0°C DB	Indoor Air Inlet Temperature:	20.0°C DB
	19.0°C WB	Outdoor Air Inlet Temperature:	7.0°C DB
Outdoor Air Inlet Temperature:	35.0°C DB		6.0°C WB
Piping Length:7.5 metre		Piping Length:7.5 metre	
Piping Lift:0 metre		Piping Lift:0 metre	

2. The sound pressure level is based on following conditions.

1.5 metre Beneath the unit.

The data in the table above was measured in an anechoic chamber so that reflected sound should be taken into consideration in the field.

VENTILATIONS



ALL FRESH AIR UNIT

Model	RPI-5.0KFNQ	RPI-8.0KFNQ	RPI-10.0KFNQ	RPI-12.0KFNQ		
Unit Power Supply	AC 1Φ, [220-240V/50Hz]	AC 1Φ, [220-240V/50Hz]	AC 1Φ, [220-240V/50Hz]	AC 3Φ, [380-415V/50Hz]		
Connectable Outdoor Unit	SET FREE Σ Heat Pump Type FSNS/FSNP Series			RAS-12FSNS/P		
Cooling	Capacity	kW	14.0	22.4	28.0	33.5
	Power	kW	0.30	0.48	0.50	0.68
	Nominal Current	A	1.40	2.20	2.30	1.43
Heating	Capacity	kW	13.7	21.9	24.5	26.8
	Power	kW	0.30	0.48	0.50	0.68
	Nominal Current	A	1.40	2.20	2.30	1.43
Sound Pressure Level (overall a scale)	dB(A)	42	44	47	56	
Dimensions H×W×D	mm	370×1,320×800	486×1,270×1,069	486×1,270×1,069	486×1,270×1,069	
Net Weight	kg	63	110	110	110	
Refrigerant		R410A	R410A	R410A	R410A	
Air Flow Rate	m ³ /min	18	28	35	50	
External Pressure	Pa	200	220	220	220	
Piping	Liquid	mm	Φ9.53	Φ9.53	Φ9.53	Φ12.7
	Gas	mm	Φ15.88	Φ19.05	Φ22.2	Φ25.4
	Condensate Drain		VP25, Outer Diameter: Φ32mm			
Temperature range of fresh air drawn		Cooling: 20.0°C~43.0°C, Heating: -7.0°C~15.0°C				

Model	RPI-16.0KFNQL	RPI-16.0KFNQH	RPI-20.0KFNQL	RPI-20.0KFNQH	RPI-20.0KFNQLF	RPI-20.0KFNQHF		
Unit Power Supply	AC 3Φ, [380-415V/50Hz]	AC 3Φ, [380-415V/50Hz]	AC 3Φ, [380-415V/50Hz]	AC 3Φ, [380-415V/50Hz]	AC 3Φ, [380-415V/50Hz]	AC 3Φ, [380-415V/50Hz]		
Connectable Outdoor Unit	RAS-16FSNS/P		RAS-20FSNS/P					
Cooling	Capacity	kW	45.0	45.0	56.0	56.0	56.0	
	Power	kW	0.72	1.06	1.06	1.39	1.39	1.72
	Nominal Current	A	1.80	2.20	2.22	3.14	3.00	3.90
Heating	Capacity	kW	36.0	36.0	44.8	44.8	44.8	44.8
	Power	kW	0.72	1.06	1.06	1.39	1.39	1.72
	Nominal Current	A	1.80	2.20	2.22	3.14	3.00	3.90
Sound Pressure Level (overall a scale)	dB(A)	58	62	61	65	63	67	
Dimensions H×W×D	mm	635×1,950×805	635×1,950×805	735×1,950×805	735×1,950×805	735×1,950×805	735×1,950×805	
Net Weight	kg	196	196	222	222	222	222	
Refrigerant		R410A	R410A	R410A	R410A	R410A	R410A	
Air Flow Rate	m ³ /min	67	67	83	83	100	100	
External Pressure	Pa	200	300	200	300	200	300	
Piping	Liquid	mm	Φ12.7	Φ12.7	Φ15.88	Φ15.88	Φ15.88	Φ15.88
	Gas	mm	Φ25.4	Φ25.4	Φ28.6	Φ28.6	Φ28.6	Φ28.6
	Condensate Drain		RC1 (Internal Screw)					
Temperature range of fresh air drawn		Cooling: 20.0°C~43.0°C, Heating: -7.0°C~15.0°C						

NOTES:

- Cooling capacity and heating capacity test in the following conditions:
Cooling conditions: 33.0°CDB, 28.0°CWB, pipeline length 7.5 metre, pipe height difference 0 metre
Heating conditions: 0°CDB, -2.9°CWB, pipeline length 7.5 metre, pipe height difference 0 metre (heating is the data without defrosting)
- Noise test conditions are as follows:
At a distance of 1.5 metre from the unit surface
The above parameters are measured in the anechoic chamber without reflected echo, therefore the impact of the reflected echo must be counted at the scene.
- An air filter with dust removal efficiency of 50% or more needs to be installed at the air inlet.
- When the field duct resistance is small and the fan speed is too high, the unit will appear the phenomena of abnormal shutdown, fault, water spray etc., and the duct pipe should be insulated to prevent generating dew.
- Air processor can only be used for processing fresh air, indoor air conditioning load processing need to use other air conditioners.
- Fresh air processing unit should be connected with SET FREE Σ Heat Pump Type outdoor unit.
When fresh air processing unit and other indoor units air all connected to the same SET-FREE outdoor unit, Its equivalent cooling capacity is calculated by the following criteria:
Type_5HP class: 21.0kW; 8HP class: 33.3kW; 10HP class: 42.0kW
- Refer to capacity restrains shown on Table below for indoor unit capacity connectable to outdoor unit.

System	All Fresh Air Unit System (Only All Fresh Air Unit)	Mixed System (All Fresh Air Unit and Other Indoor Unit)
Range of Combination Capacity	80 to 100%	i) 80 to 100% and ii) Total Capacity of All Fresh Air: 30%

- When outdoor temperature is below 20.0°C in cooling operation, the system will be automatically converted to ventilation operation.
When outdoor temperature is higher than 15.0°C in heating operation, it will be automatically converted to ventilation operation. When lower than -7.0°C, the fresh air processing unit will stop running.



TOTAL HEAT EXCHANGER

Model		KPI-2521	KPI-5021	KPI-8021	KPI-10021 (*1)
Unit Power Supply		AC 1Φ, [220-240V/50Hz]			
Air Flow Rate	(Hi/Me/Lo) m ³ /h	250/250/165	500/500/350	800/800/670	1,000/1,000/870
External Pressure	(Hi/Me/Lo) Pa	65/40/20	150/60/30	140/100/70	160/100/80
Temp. Exchange Efficiency	(Hi/Me/Lo) %	78/78/83	77/77/82	78/78/80.5	79/79/81
Enthalpy Exchange Efficiency	For Heating (Hi/Me/Lo) %	69/69/74	67/67/73	71/71/73	70/70/73
	For Cooling (Hi/Me/Lo) %	62.5/62.5/68	61.5/61.5/68	64.5/64.5/68	64.5/64.5/67
Sound Pressure Level (Over A Scale)	at 1.5m from the unit (under) (Hi/Me/Lo) (*2)(*4) dB(A)	26.5-27.5/25-26/21-22	32.5-33.5/30-31/23.5-24.5	33.5-34.5/32-33/30-31	36-37/34-35/31.5-32.5
	at Air Outlet (Hi/Me/Lo) (*3)(*4) dB(A)	33.5-34.5/32-33/26-27	40.5-41.5/38-39/29.5-30.5	44.5-45.5/43-44/40-41	47-48/45-46/41.5-42.5
Outer Dimensions	Height mm	275	317	398	398
	Width mm	735	1,016	1,004	1,231
	Depth mm	780	888	1,164	1,164
Net Weight	kg	21	33	61	72
Connection Duct Diameter	mm	Φ150	Φ200	Φ250	Φ250

NOTES:

(*1): KPI-10021 has different units according to the applied power supply, 220-240V/50Hz.

(*2): The sound pressure level is based on following conditions.

1.5 metre beneath the unit and this data was measured in an anechoic chamber so that reflected sound should be taken into consideration in the field.

(*3): The noise at the air outlets is the values at a 45° angle, 1.5 metre in front of the unit.

(*4): The sound pressure level is based on the total heat exchange mode.

In case of the bypass ventilation mode, the sound pressure level increase by approximately 1 dB(A).





CONTROLLERS

77 LINE UP OVERVIEW

79 INDIVIDUAL CONTROLLERS

79 SIMPLIFIED WIRED REMOTE CONTROLLER
PC-ARH1

80 WIRELESS REMOTE CONTROLLER
PC-AWR

RECEIVER KIT
FOR WIRELESS REMOTE CONTROLLER

81 ADVANCED WIRED REMOTE CONTROLLER
PC-ARF1

85 CENTRALISED CONTROLLERS

85 CENTRAL STATION mini
FOR SMALL-SCALE BUILDINGS
PSC-A32MN

87 CENTRAL STATION EZ
FOR MEDIUM-SCALE BUILDINGS
PSC-A64GT

89 CENTRAL STATION EX
FOR LARGE-SCALE BUILDINGS
PSC-A128EX

93 H-LINK

95 OTHERS

95 3P Connector Cable
(For Connection to Remote On/Off Device / Receipt of Output Signal)
PCC-1A

Remote Sensor
(To sense the indoor temperature)
THM-R2A

Remote Control Cable
(For PC-ARF1 connection (to IDU))
PRC-5K, 10K, 15K

96 BMS ADAPTER for BACnet®
Control up to 64 Indoor Units
HC-A64BNP1

LINE UP OVERVIEW

COMPARING INDIVIDUAL CONTROLLERS

SIMPLIFIED WIRED REMOTE CONTROLLER



PC-ARH1

ADVANCED WIRELESS REMOTE CONTROLLER



PC-AWR

ADVANCED WIRED REMOTE CONTROLLER



PC-ARF1

		PC-ARH1	PC-AWR	PC-ARF1	
Connection Capacity	RC Groups	1	-	1	
	Indoor units (*1)	16	-	16	
Setting	Temperature Setting Rate (*2)	0.5°C/1.0°C/1.0°F	0.5°C/1.0°C/1.0°F	0.5°C/1.0°C/1.0°F	
	Indoor Fan Speed (*2) (*3)	3/4/6 taps	3/4/6 taps	3/4/6 taps	
	Louvre Direction (*2)	●	●	●	
	Individual Louvre Setting (*2)	-	-	●	
	Remote Control Primary-Secondary Setting	●	-	●	
	Function Selection	Automatic Restart with Eco-operation	-	-	●
		Automatic Reset Temperature (Cooling)	●	-	●
		Temperature Indication (*4)	-	-	●
	Service & Installation	Filter Sign	-	-	●
		Filter Sign Reset	-	●	●
Louvre Open/Close		-	-	●	
Room Name Setting		-	-	●	
Alarm Sign		●	-	●	
Identifying indoor units side-by-side		-	●	-	
Screen		Screen Adjustment	-	-	●
		Language	-	-	●
		Temperature Unit - °C/°F	● (*5)	●	●
Check Menu		Adjusting Brightness of Run Indicator	-	-	●
		Sensor Condition Check	-	-	●
		Model Display (*2)	-	-	●
		Indoor/Outdoor PCB Check	-	-	●
Management		Alarm History Display	-	-	●
		Operation Lock/Set	-	-	●
		Lower Limit for Cooling Operation	●	-	●
		Upper Limit for Heating Operation	●	-	●
	Built-in Timer (On/Off)	-	●	●	
	Adjusting Date/Time Setting	-	-	●	
	Automatic OFF timer setting	●	-	●	
	Schedule	Weekly Schedule	-	-	●
		Settable Timer Operation Times (Per Day)	-	-	5
		Holiday Setting	-	-	●
Schedule On/Off		-	-	●	
Power Saving	Power Saving with Motion Sensor	-	-	●	
	Outdoor Unit capacity control	Peak cut control	-	●	
		moderate control	-	-	●
	Indoor Unit Rotation Control	Indoor Unit Address	-	-	●
	Indoor Air Temperature difference	-	-	●	
	Automatic Fan Operation	-	-	●	
MENU	ODU silent mode	-	-	●	
	Quick Function	-	-	●	
	Comfort setting Control Cool Air	-	-	●	
	Saving/ODU Noise Reduction Schedule	-	-	●	
	Daylight Saving Time	-	-	●	
Power Consumption visualisation	-	-	●		

(*1) All 16 indoor units need to be connected with transition wire.

(*2) Availability depends on the indoor unit type connected to the each individual controllers. Please consult your distributors for more details.

(*3) 6 taps is available for RPIZ-HNDTSQ only.

(*4) Indicated temperature can be selected from two options, the thermistor in the indoor unit or in the individual controller.

(*5) Please contact your distributor in case temperature unit needs to be changed from °C to °F.

COMPARING CENTRALISED CONTROLLERS

CENTRAL STATION mini



CENTRAL STATION EZ



CENTRAL STATION EX



PSC-A32MN

PSC-A64GT

PSC-A128EX

		PSC-A32MN	PSC-A64GT	PSC-A128EX	
Capacity comparison	Total Connection capacity	RC group	32	64	2,560 (*1)
		Group	4	64	2,048 (*1)
		Block	2/4/8/16	4	512 (*2)
		Area	-	-	512 (*2)
		Indoor unit	160	160	2,560 (*1)
		Outdoor unit	64	64	1,024 (*1)
		Building scale	Small	Medium	Large
	Operation	Touch screen	Touch screen	Touch screen	
Display	Operation panel size options	4	2	7	
	Layout	-	-	●	
	List options	-	-	3	
Operation unit	All together	●	●	●	
	By layout	-	-	●	
	By area	-	-	●	
	By block	●	●	●	
	By group	-	-	●	
	By RC group	●	●	-	
	By indoor unit	-	-	●	
Control Function	Main 5 functions (*5)	●	●	●	
	Individual controller lock	●	△ (*3)	●	
	Filter sign reset	●	●	●	
	Outdoor unit capacity control	△ (*4)	-	●	
	Outdoor unit noise control	-	-	●	
Monitor Function	Main 5 functions (*5)	●	●	●	
	Individual controller lock	●	●	●	
	Alarm status & code	●	●	●	
	Filter sign	●	●	●	
	Air inlet temperature of indoor unit	●	●	●	
	Air inlet temperature of outdoor unit	●	●	●	
Schedule Function	Weekly	●	●	●	
	Setting times per day	10	10	16	
	Special day setting	-	-	5	
Other function	Annual/Summer/Winter schedule	-	-	●	
	Alarm history (records number)	100	100	10,000	
	External in/output history	-	-	1,000	
	Management report visualisation	●	●	●	
	Data output by external media	-	-	SD card, USB flash device	

(*1) One external adapter can control [128 remote controller groups/128 groups/32 blocks], and Central Station EX can connect up to 15 adapters.

(*2) No restriction on the number of H-LINK

(*3) Individual Function Control in Each Remote Controller is not applicable

(*4) Applicable by Schedule function or External Signal input

(*5) Main 5 functions mean 1) Run/Stop 2) Operation mode 3) Temperature setting 4) Fan speed 5) Louvre control

SIMPLIFIED WIRED REMOTE CONTROLLER **PC-ARH1**

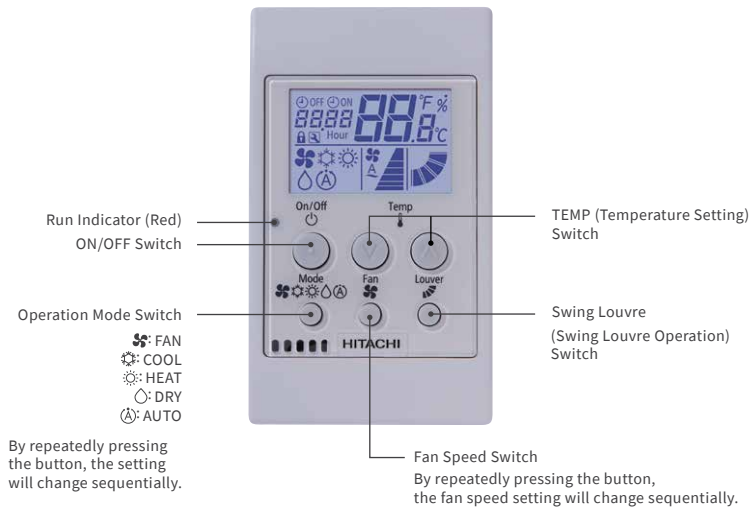

SPECIFICATIONS

Outer Dimensions (H×W×D)

(mm) 120.0×70.0×17.0

FUNCTIONS

Setting	Run/Stop
	Operation Mode
	Auto Mode Setting
	Temperature Setting
	Temperature Setting Rate_0.5°C/1.0°C/1.0°F
	Back-light screen
	Fan Speed_3/4/6 taps
Louvre Direction	

*Please contact your dealer in case "temperature setting rate" needs to be changed from °C to °F.

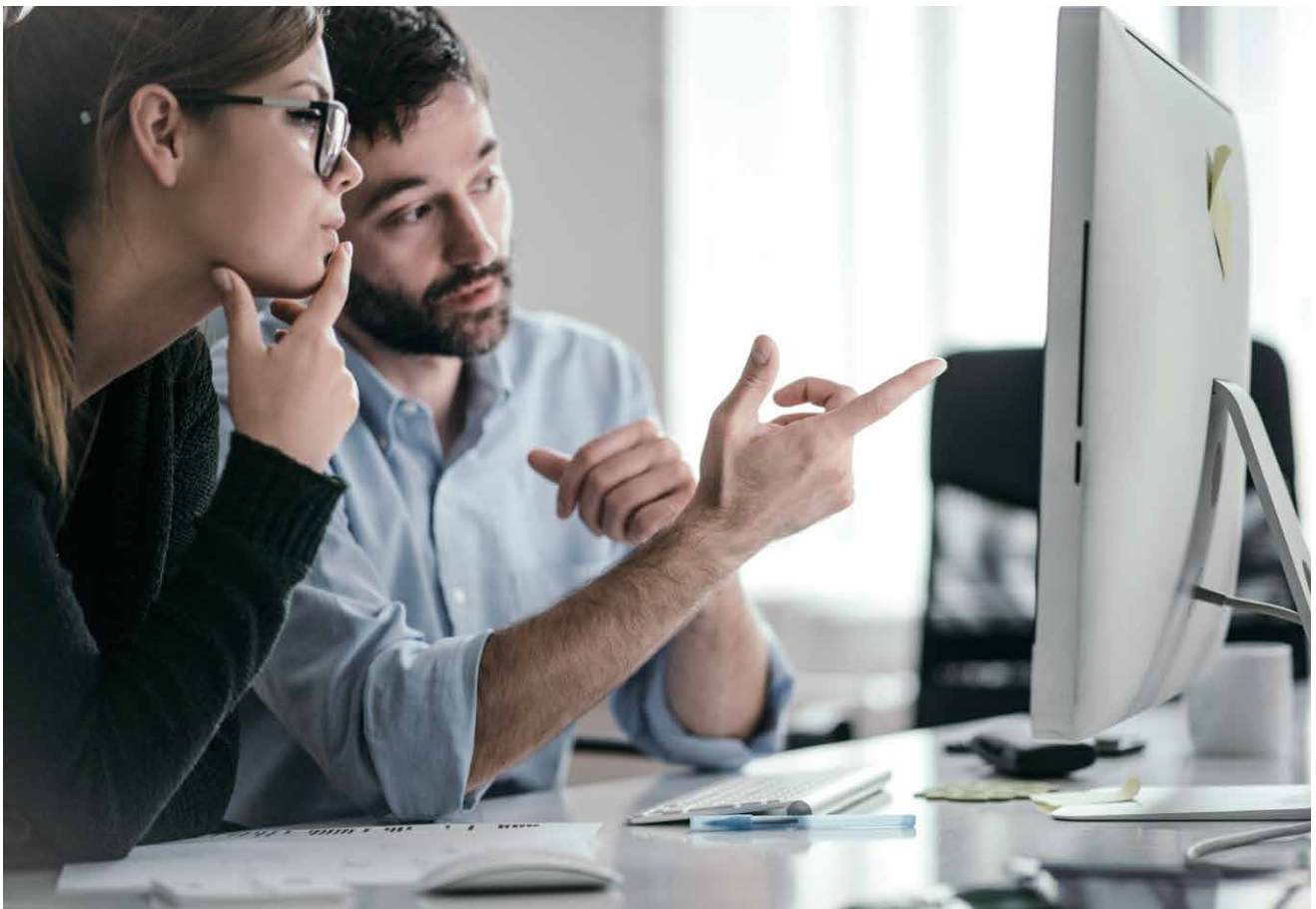

WIRELESS REMOTE CONTROLLER PC-AWR



SPECIFICATIONS

Outer Dimensions (H×W×D)
(mm) 140.0×55.0×16.8

FUNCTIONS

	Run/Stop
	Operation Mode
	Auto Mode Setting
Setting	Temperature Setting
	Temperature Setting Rate_0.5°C/1.0°C/1.0°F
	Fan Speed_3/4/6 Taps
	Louvre Direction
	Filter Sign Reset
Service	Identifying indoor units side-by-side
	Temperature Unit_°C/°F
Schedule	Built-in Timer (On/Off)

EXAMPLE OF SYSTEM CONFIGURATION

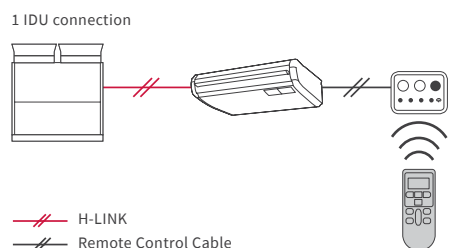

RECEIVER KIT FOR WIRELESS REMOTE CONTROLLER

Model	PC-ALHZ1					PC-ALHP1	PC-ALH3	PC-ALHC1	PC-ALHD1	PC-ALHS1
For indoor unit model	Ducted	Wall Mounted	Floor/Ceiling Convertible	Floor Exposed	Floor Concealed	Ceiling Suspended	4-Way Cassette	4-Way Cassette Compact	2-Way Cassette	1-Way Cassette

ADVANCED WIRED REMOTE CONTROLLER **PC-ARF1**

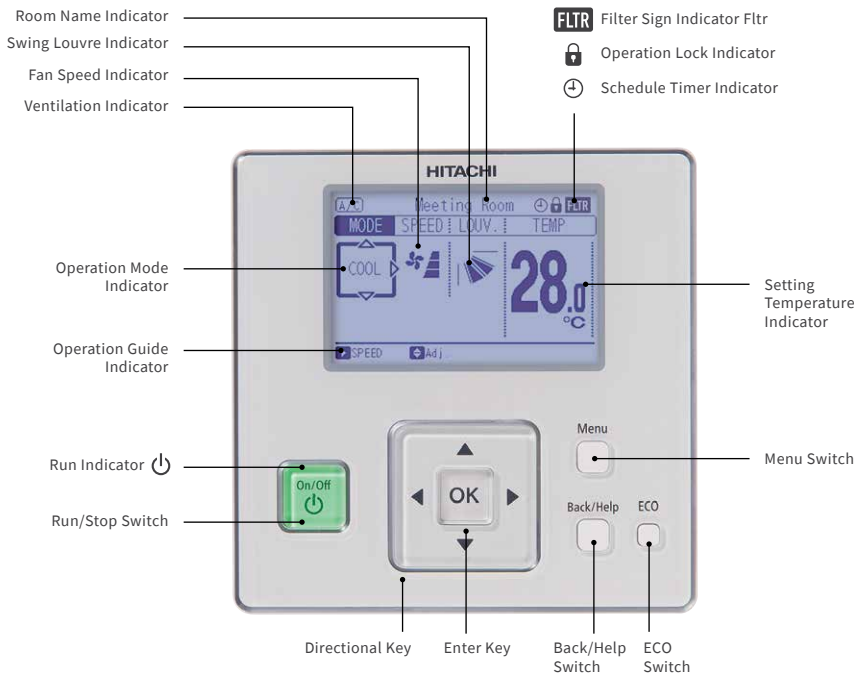

SPECIFICATIONS

Outer Dimensions (H×W×D)

(mm) 120.0×120.0×17.9

EXAMPLE OF SYSTEM CONFIGURATION

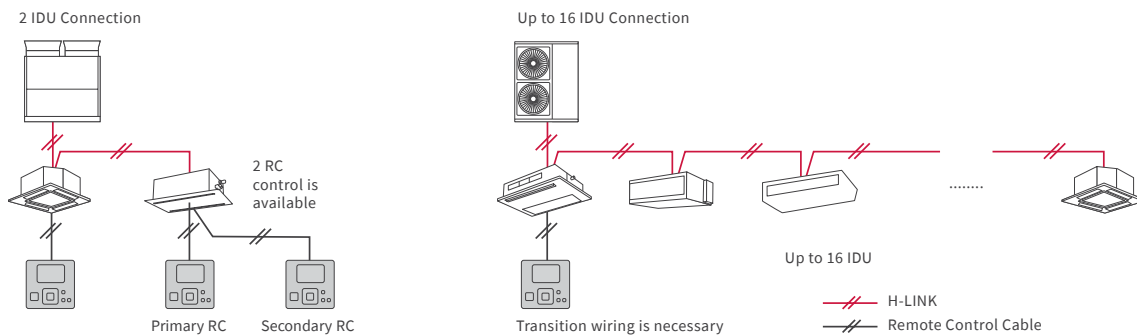

FUNCTIONS

Setting	Run/Stop	Screen	Screen Adjustment	Management	Operation Lock/Set
	Operation Mode		Language		Main/Sub Control
	Auto Mode Setting		Temperature Unit_°C/°F		Built-in-Timer (On/Off)
	Temperature Setting		Adjusting Brightness of Run Indicator		Adjusting Date/Time Setting
	Temperature Setting Rate_0.5°C/1.0°C/1.0°F		Sensor Condition Check		Thermometer Indication
	Fan Speed_3/4/6 Taps		Sensor Data Check		With Motion Sensor Kit
	Louvre Direction		Model Display		ODU Capacity Control
	Individual Louvre Setting		Indoor/Outdoor PCB Check		• Peak-cut Control
	Remote Control Primary-Secondary Setting		Self Checking		• Moderate Control
	In Use of Total-Heat-Exchanger		Alarm History Display		Power-Saving
Ventilation	Test Run	Automatic Fan Operation			
Total Heat Exchanger Setting	Function Selection (Optional Function Setting)	Auto Recovery of Temperature			
Automatic Restart with Eco-operation	Thermistor Selection	Upper Limit for Heating Operation			
Function Selection	Input/Output Setting	Lower Limit for Cooling Operation			
Automatic Reset Temperature (Cooling/Heating)	Indoor Unit Address Change	Power Consumption Visualisation	Schedule		
Temperature Indication	Indoor Unit Address Checking Operation	Weekly Schedule			
Service	Filter Sign	Indoor Unit Address Initialisation		Settable Timer Operation Times (per day): 5	
	Filter Sign Reset	Input-Output Setting Initialisation		Holiday Setting	
	Louvre Open/Close	Compressor Pre-Heat Control Cancellation		Schedule On/Off	
	Room Name Setting	Contact Information Registration	ODU Noise Reduction Schedule		
	Alarm Sign				

COMFORT

GentleCool Control



Set your comfortable temperature not only for "Room" but also for "Air" in cooling operation. To make your room reach to the desired temperature faster, the discharged air from the indoor unit can be sometimes much cooler, causing discomfort at the beginning of operation. Now, you can choose "discharge air temperature = your own comfort level", as you like, by our advanced wired remote controller PC-ARF1. You can be in comfort and avoid cold draft from the moment when cooling operation starts, while the room gently cools down.

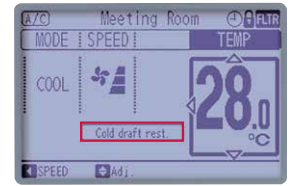

"Comfort Setting" Control Cool Air in PC-ARFPE1

Potential Discomfort

GentleCool → No Cold Draft



AWAY FUNCTION



Off set the temperature when the space is not occupied reducing the power consumption
Optional accessories required

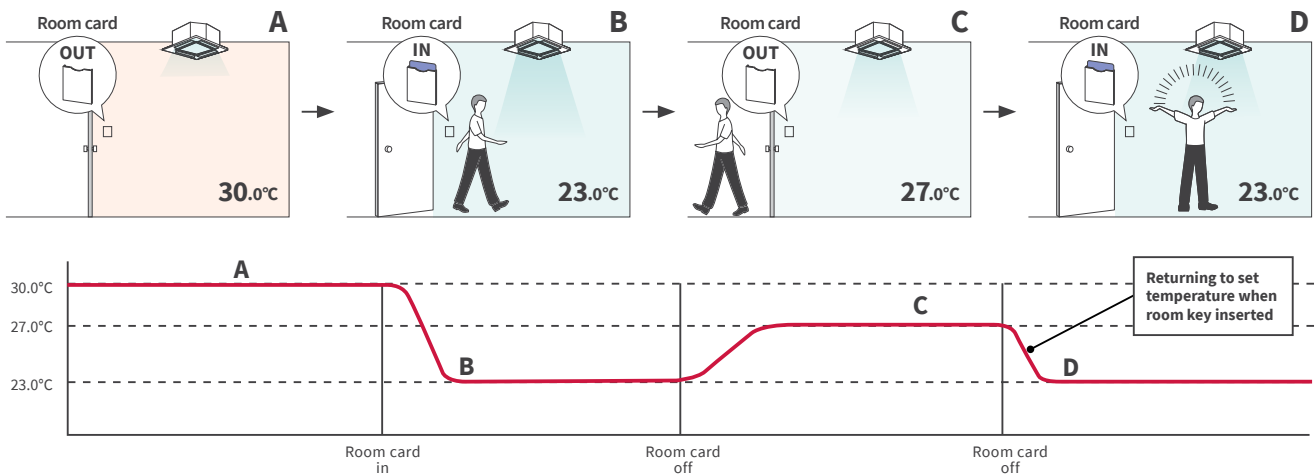

ADVANCED WIRED REMOTE CONTROLLER PC-ARF1

POWER-SAVING FUNCTION

With Motion Sensor

Perceives the amount of human activity and undertakes automatic saving.

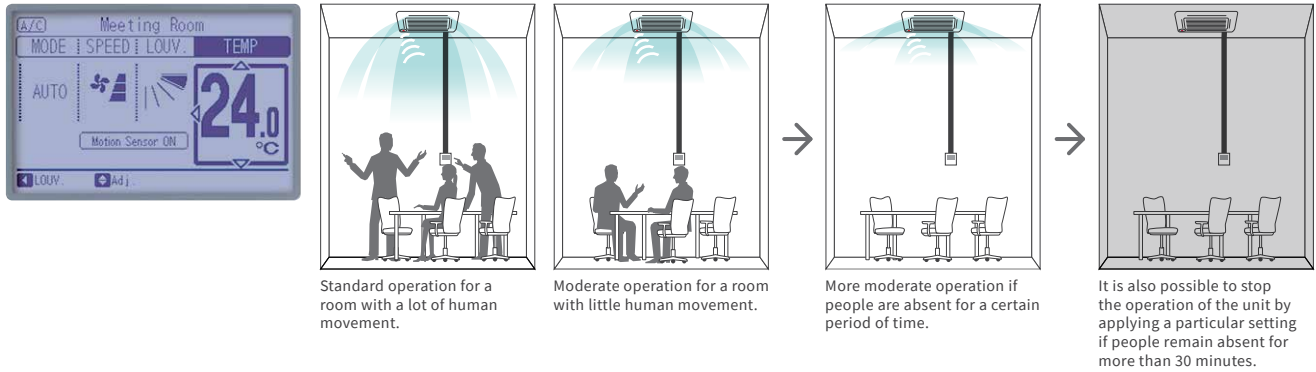

Outdoor unit capacity control ⇔ two options

(1) Peak-cut control: set the limit on the power consumption range

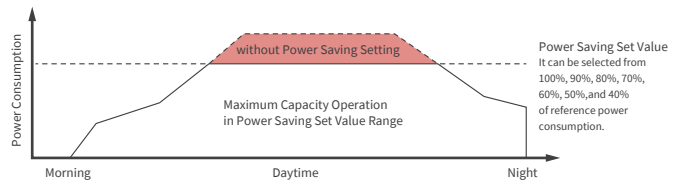
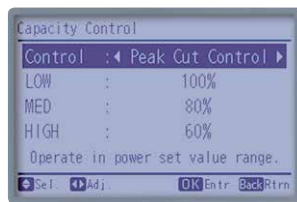

(2) Moderate control: keep the power consumption within proper limit (40-90%)

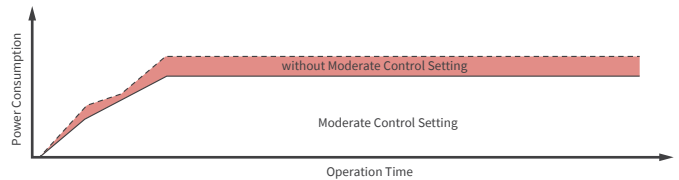
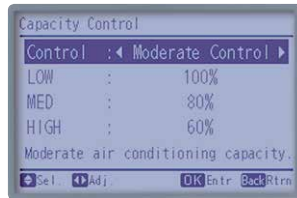

Indoor Unit Rotation Control

Switch multiple indoor units operation to "FAN" mode, one by one, in order.

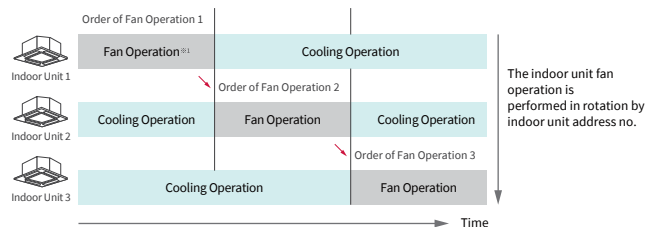
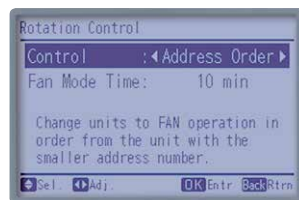

Automatic fan operation

Alternate between "heating/cooling" and "FAN" at a certain interval.

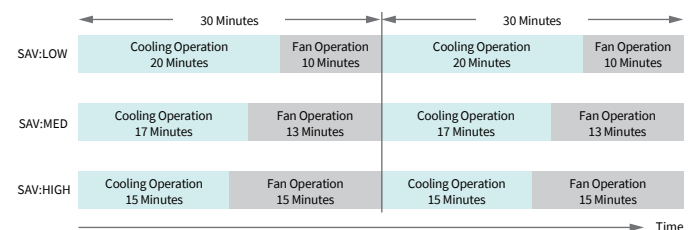
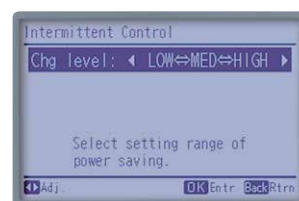

Auto-Recovery of Temperature

Reducing excessive energy consumption thanks to automatic temperature reset.

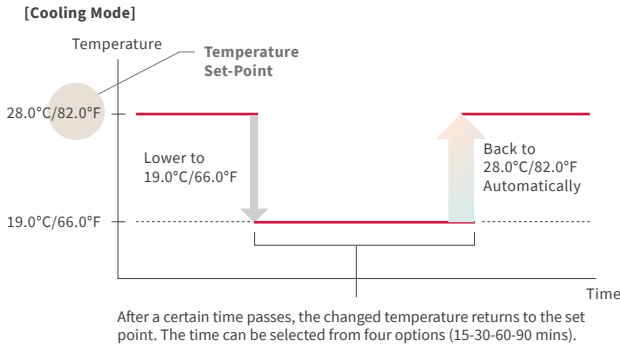

Weekly Schedule

Seven-day timer with multiple set-points (up to 5 actions per day): No need to worry about controlling the air conditioner each time, each day.

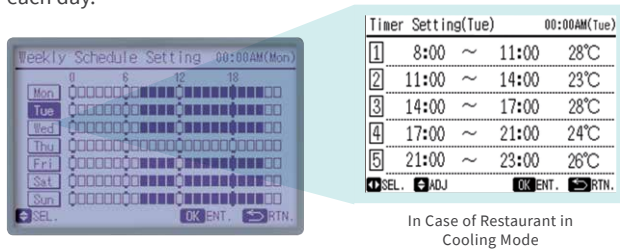

Temperature Range Setting

Prevent wasteful power consumption due to excessive use of cooling/heating mode.

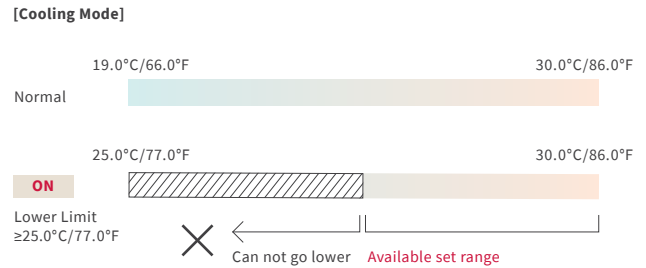

Power consumption visualisation

Check power consumption in the unit of day, week, and year. ※ ODU compressor only

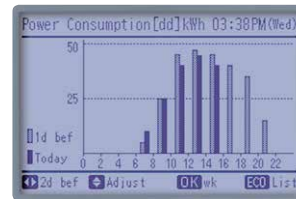

ADAPTABILITY

Improved main-sub RC control

By one main RC, you can control the multiple IDUs which are controlled by sub RC.

- * Operation Mode
- * Setting Temperature

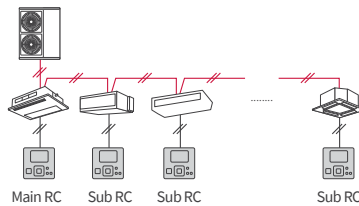

Temperature Setting Rate

Setting available in 0.5°C/1.0°C or 1.0°F.



Alarm code check

Contact address shown in the same display.



Thermometer function

Current temperature can be displayed anytime, without being in maintenance mode.

*Thermometer can be chosen out of 4 sensors (Air inlet, Air outlet, Remote controller and Remote Sensor (THM-R2A))



ODU silent mode

Set in the weekly schedule by 5 times.



Help Menu

Access when in trouble. Screen guide, Operation Manuals, Troubleshooting Q&A listed.

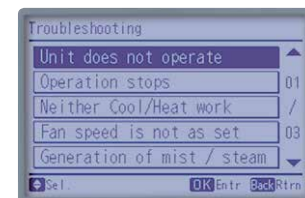

CENTRAL STATION mini FOR SMALL-SCALE BUILDINGS PSC-A32MN

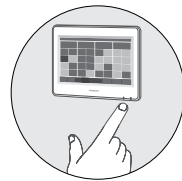

Most compact in our touch panel centralised controller. Its down-to-detail control functionalities, such as Weekly Scheduling, Accumulated Work Hours, etc., help you save energy. Up to 32 remote-controlled groups and up to 160 indoor units can be connected to the single air-conditioning system.

CAPACITY

RC group	32
Group	32
Block	4 Patterns (2/4/8/16)
Indoor Unit	160
Outdoor Unit	64
Building Scale	Small

SPECIFICATIONS

Rated Power Supply	1-, AC 100-240V, 50/60Hz
Electrical Power Consumption	20W (Max.)
Communication Unit	Units of Adopting for H-LINK
Communication Line	Non-polar 2-wire
Communication Speed	9,600bps
Wiring Length	1,000m (Total Length)
Display	5.0-inch Wide Colour LCD (Full Dot)
Display Control	Touch Panel

FUNCTIONS

Monitor Function	<ul style="list-style-type: none"> • Run/Stop/Abnormality • Setting Temperature • RC Operation Prohibited Setting • Accumulated Operating Time • Operation Mode • Setting Fan Speed • Setting Louvre • Filter Sign • Alarm Code"
Control Function	<ul style="list-style-type: none"> • Run/Stop" • Fan Speed • Operation Mode • Louvre • Temperature Setting • RC Operation Prohibited • Filter Sign Reset

* "All Groups Run/Stop" command signal exception function for selected groups is available by "Exception of Run/Stop Operation." function.

EXAMPLE OF SYSTEM CONFIGURATION

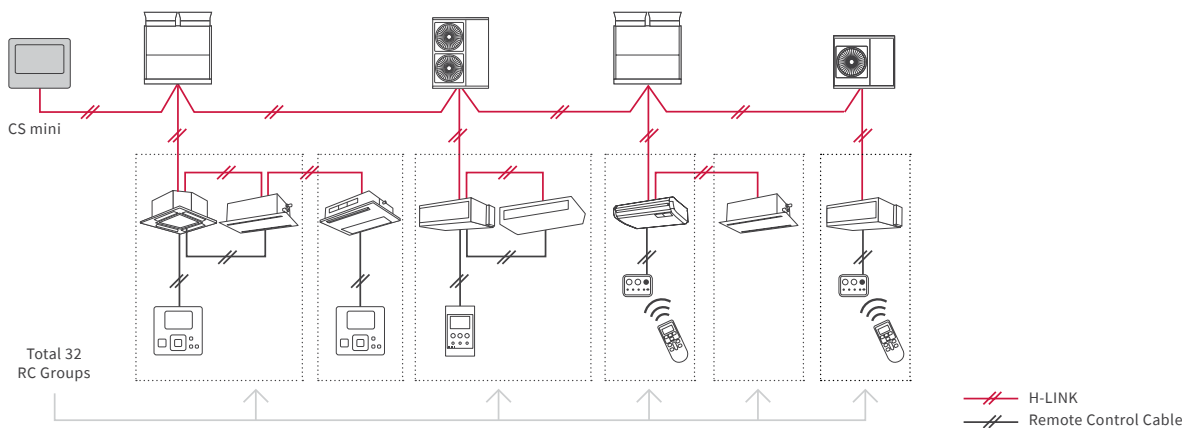

(5-inch) Touch Panel Operation

Easy to check the operation status using either of two monitoring screens (all groups or four pattern blocks [2/4/8/16])

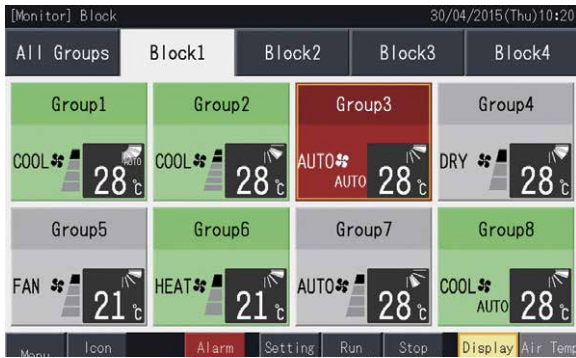

[Monitor (Block)]

Schedule

Up to 10 actions/day per RC group can be set as available as auto switch-off timer



Time	Temp (°C)	Class Status
9:00 ~ 10:00	27	Class: on
10:00 ~ 11:00	27	Class: on
11:00 ~ 12:00	-	No class: off
12:00 ~ 13:00	25	LUNCH TIME
13:00 ~ 14:00	-	No class: off
14:00 ~ 15:00	27	Class: on
15:00 ~ 16:00	-	No class: off
16:00 ~ 17:00	27	Class: on
17:00 ~	-	No class: off

RC Group Function Control

-each operational item blocking-prevent incorrect operation

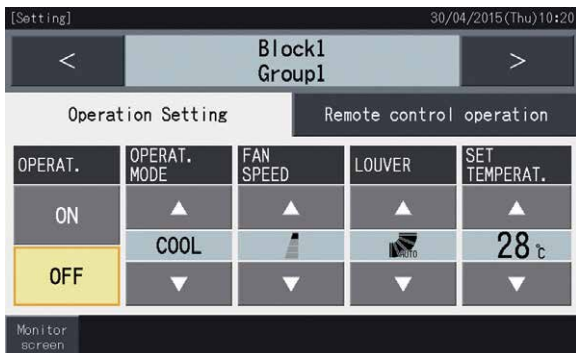

ON/OFF, "operation mode," "fan speed," "swing louvre direction," "setting temperature," and "prohibition of remote control operation for individual items (run/stop, operation mode, fan speed, wind direction, setting temperature)"

Accumulated Operation-Time Visualisation

Support energy-saving management

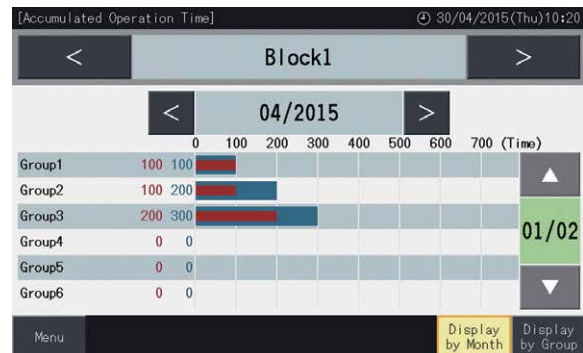

Energy Saving

Outdoor unit power consumption control by schedule or external signals. Setting temperature range.

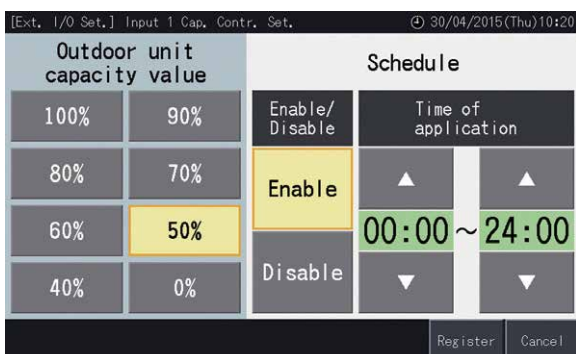

[Capacity Control of ODU]

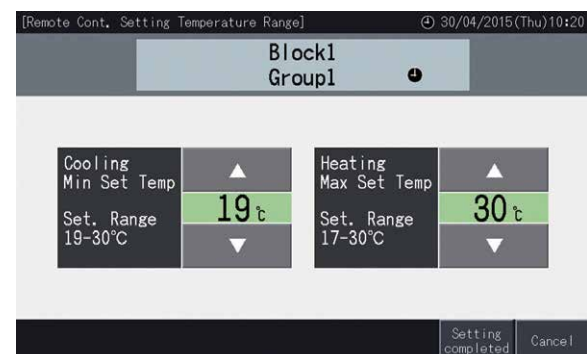

[Temperature Limitation for Each Remote Controller]

CENTRAL STATION EZ FOR MEDIUM-SCALE BUILDINGS

PSC-A64GT

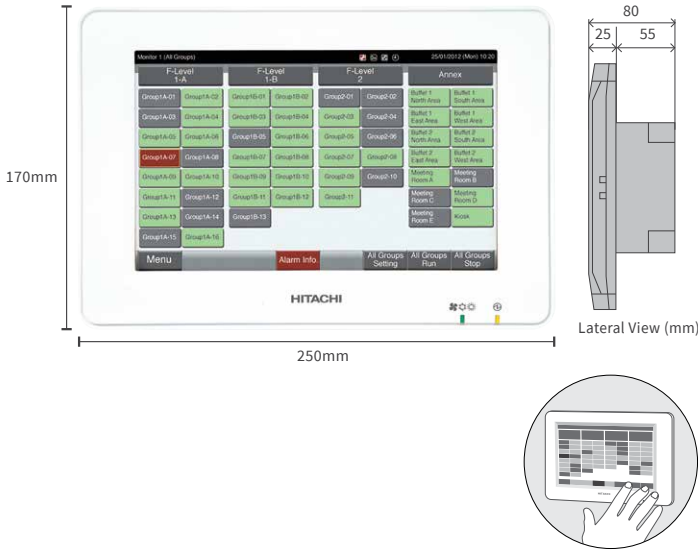

Easy control with 8.5 inch colour touch panel, Its down-to-detail control functionalities, such as Weekly Scheduling, Accumulated Work Hours, etc., help you save energy. Up to 64 remote-controlled groups and up to 160 indoor units can be connected to the single air-conditioning system.

CAPACITY

RC group	64
Group	64
Block	4 Patterns
Indoor Unit	160
Outdoor Unit	64
Building Scale	Small-Medium

SPECIFICATIONS

Rated Power Supply	1-, AC 100-240V, 50/60Hz
Electrical Power Consumption	30W (Max.)
Communication Unit	Units of Adopting for H-LINK
Communication Line	Non-polar 2-wire
Communication Speed	9,600bps
Wiring Length	1,000m (Total Length)
Display	8.5-inch Wide Colour LCD (Full Dot)
Display Control	Touch Panel

FUNCTIONS

Monitor Function	<ul style="list-style-type: none"> Run/Stop/Abnormality Setting Temperature RC Operation Prohibited Setting Accumulated Operating Time Operation Mode Setting Fan Speed Setting Louvre Filter Sign Alarm Code
Control Function	<ul style="list-style-type: none"> Run/Stop* Fan Speed Operation Mode Louvre Temperature Setting RC Operation Prohibited Filter Sign Reset

* "All Groups Run/Stop" command signal exception function for selected groups is available by "Exception of Run/Stop Operation." function.

EXAMPLE OF SYSTEM CONFIGURATION

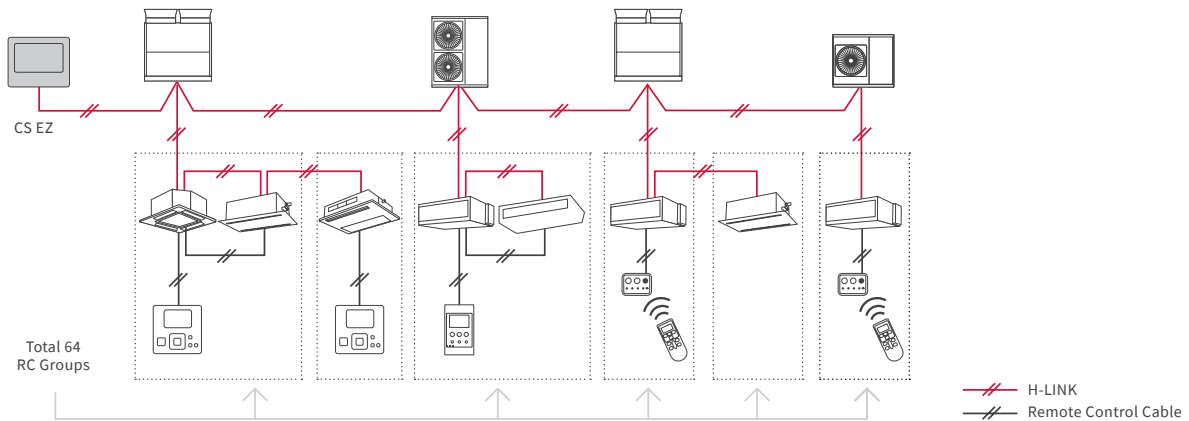

(8.5-inch) Touch Panel Operation

A total of 64 remote controller groups (4 blocks)(64 outdoor units/160 indoor units) can be controlled
 Easy to check the operation status using either of two monitoring screens (all groups or blocks)

The panel for the block is bigger than for the CS MINI; you can check Mode, Fan Speed, Louvre, Temperature, Inlet and Ambient Temperature.



[Monitor 1 (all groups)]



[Monitor 2 (block)]

ACCUMULATED OPERATION-TIME VISUALISATION

Supports Energy-Saving Management

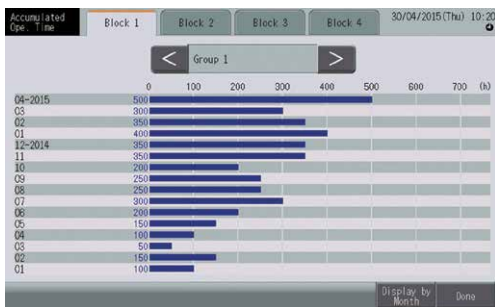

Alarm Information

Red colour indication: immediate display of malfunction location and cause.

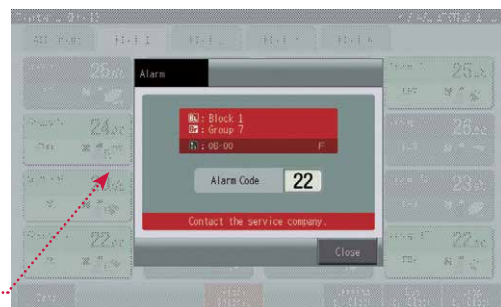
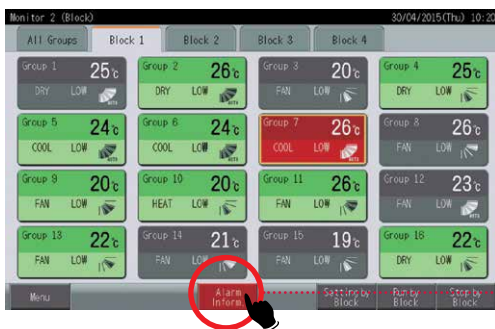

Schedule

Up to 10 actions/day per RC groups can be set as available as auto switch-off timer.



[Weekly Schedule]



[Holiday Setting]

CENTRAL STATION EX FOR LARGE-SCALE BUILDINGS

PSC-A128EX



Extension Adapter
PSC-AD128EX



Energy Calculation Software*
PSC-AS01EXC

*Required only for calculating electricity

CAPACITY

H-LINK	16
RC group	2,560 (*1)
Group	2,048 (*1)
Block	512 (*2)
Area	512 (*2)
Indoor unit	2,560 (*1)
Outdoor unit	1,024 (*1)
Building scale	Large

(*1) One external adapter can control [160 RC groups/128 groups/160 IDUs/64 ODU/Each layout], and Central Station EX can connect up to 15 adapters.
(*2) No restriction on the number of H-LINK

SPECIFICATIONS

Rated power supply	100~240VAC ±10% (50/60Hz)
Electrical power consumption	50W (Max.)
Communication unit	Units of Adopting for H-LINK
Communication line	Nonpolar Two Wires
Communication speed	9,600bps
Wiring length	1,000m (Total Length)
Display	12.1 inch TFT colour liquid crystal display
Display control	Touch Panel

For large scale buildings such as hotels, educational facilities, or hospitals, our Central Station EX features a highly intuitive and functional 12.1-inch wide, wall-mountable, colourful LCD screen. Control up to 2,560 indoor units with our proprietary H-LINK system with 15 Extension Adapters (PSC-AD128EX)

FUNCTIONS

Operation unit	All together Each area Each block Each group Each RC group			
Control function	On/Off Mode Set temperature Fan speed Louvre RC prohibition Filter sign reset Function selection for indoor units (*1) Function selection for outdoor units (*2) Capacity control for outdoor units (*2) Lower noise control for outdoor units (*2)	Schedule function	Each of the following setting is available in 3 different [annual] [summer][winter] category → Weekly schedule → Up to 16 actions can be set per day → Exception day setting: 5 different types → Holiday setting	Energy saving
Monitor function	On/Off Mode Set temperature Air intake temperature RC sensor temperature (*3) Air intake temperature of outdoor unit Fan Speed Louvre RC prohibition Thermo-ON information Filter sign/Auto cleaning fault Alarm status/Alarm codes	History	Setting items in schedule is as below; • On/Off • Operation mode • Setting temperature • Louvre • Fan speed • RC operation prohibition • Capacity control for outdoor units • Lower noise control for outdoor units Alarm history: 10,000 records External In/Output history: 1,000 records Pulse input history: 6 months	External input / output
		Management report visualisation	Each of the following data of up to 2 years can be shown: • Accumulated operation time (min.) • Accumulated thermo-ON time (min.) • Average air intake temp temperature of indoor unit • Average air intake temperature of outdoor unit • Average setting temperature • Average RC sensor temperature	Control/Monitor → Controlled items: • Run/Stop • Mode (Cool/Heat) → Monitored items: • Run/Stop • Mode (Cool/Heat) • Alarm state
				Others • Power consumption signal input • Emergency stop

(*1) Some indoor units may not fully support all functions.
(*2) It is available for applicable outdoor units only.
(*3) There is a case that it cannot be shown in the screen, depending on the remote controller setting.

EASY TO READ, EASY TO USE

The stand-alone Central Station EX uses a touch screen, capacitive LCD panel.

Better display resolution (1,280×800)
Larger screen (12.1 inches wide)



BETTER ENERGY SAVING AND QUICKER MANAGEMENT

Management reports can be visualised in various ways, and data can be acquired using SD memory and USB flash devices.

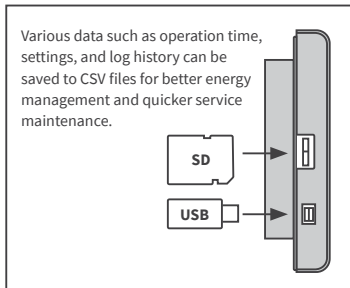

The following data can be displayed up to the previous two years:

- Accumulated operation time (min.)
- Accumulated thermo-ON time (min.)
- Average air intake temperature of indoor unit
- Average air intake temperature of outdoor unit
- Average setting temperature
- Average RC sensor temperature (It may not be available depending on RC settings.)

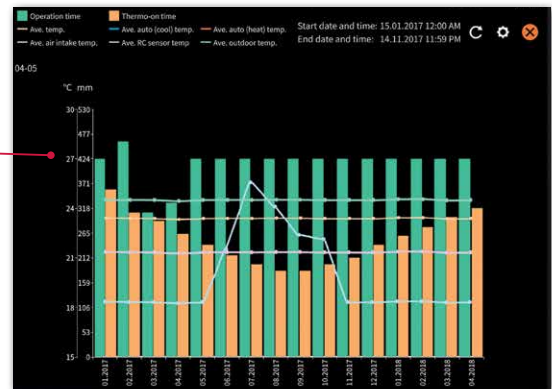

IMPROVED SCHEDULE SETTING

Three long-term category settings are now available: Annual, Summer, and Winter.

Touch and hold the memory axis to add the memory to the schedule

Schedules can be colour coded for easy confirmation

Touch the + button to see the detailed schedule

Drag to change the schedule
Flick and swipe to see a different screen

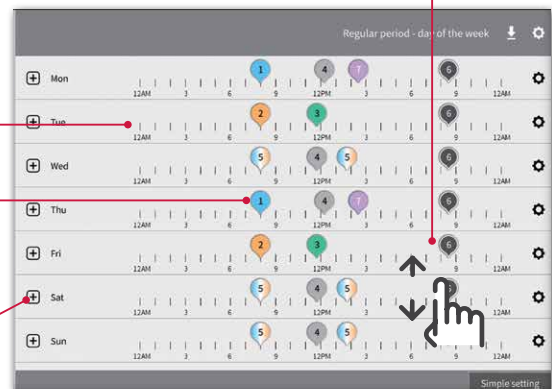

CENTRAL STATION EX FOR LARGE-SCALE BUILDINGS

PSC-A128EX

INTUITIVE INTERFACE FOR BETTER MONITORING

Three monitoring styles are available.

1. Panel style

The panel colour clearly shows the air conditioner operation mode.

One maximum-sized panel can show the following items with colours and icons for easy confirmation:

- Room name
- Run/stop
- Mode
- Temperature
- Fan speed
- Louvre
- Air intake temperature (RC sensor temperature or indoor temperature)
- Current status icon

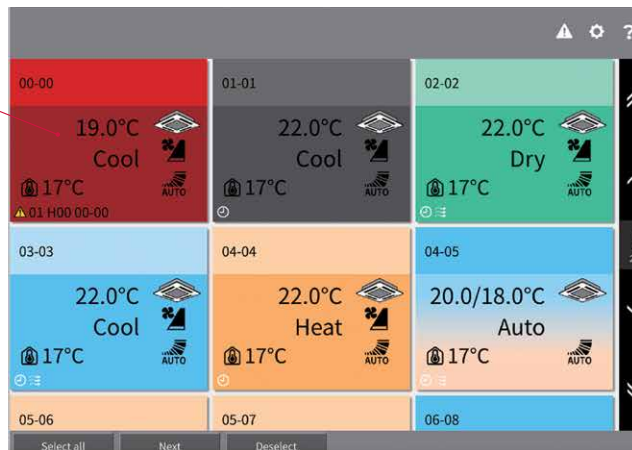
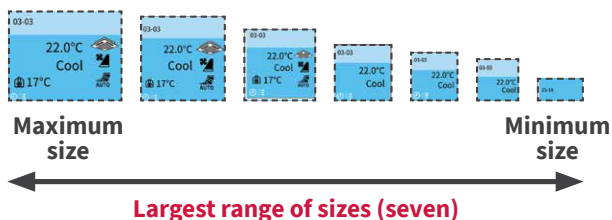

2. Layout style

Upload your own layout images in multiple formats (BMP, JPEG, PNG) and easily arrange indoor units by dragging them on the touch panel.

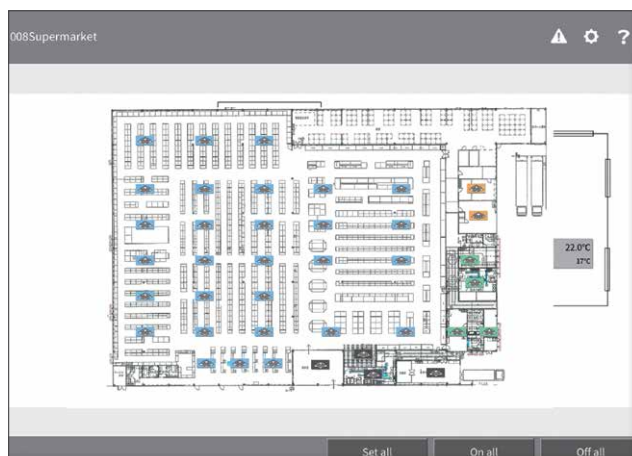

Floor view

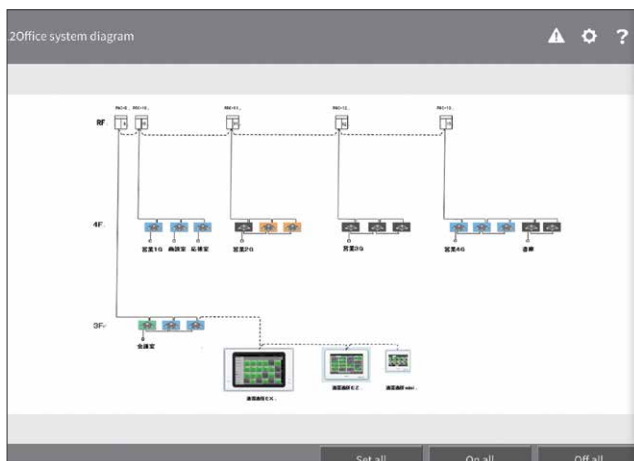

System diagram



Actual room image

3. List style

Setting/control information is shown in a list that can be filtered and sorted for easy confirmation and comparison. In the list display, normal temperature and power consumption are provided so users can select formats according to their desired items.

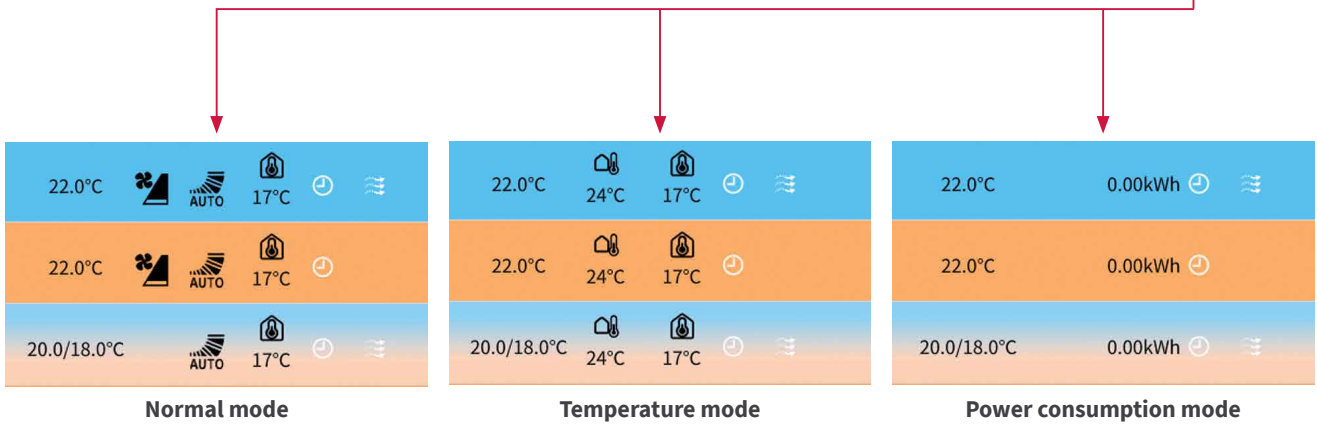

H-LINK

WHAT IS H-LINK?

H-LINK is a "Hitachi" original communication system that can be used to control multiple outdoor and indoor units from one control point. Its use assists installers and service engineers by simplifying commissioning and service maintenance. For building owners and occupants, it provides outstanding versatility enabling the connection of various types of central control options, enabling better system management. Our proprietary high-performance communication system enables the connection of control wiring between indoor and outdoor units, and between a centralised control system and indoor/outdoor units across two or more refrigerant systems.

ADVANTAGES

1. A multi air conditioner for a building and a package air conditioner for a store or office. It can be used with a home air conditioner.
2. There are no restrictions on the delivery route or order for wiring.
3. Just connect to a terminal block. (An adapter and a dedicated connector are not necessary.)

RECOMMENDED FACILITIES (EXAMPLE)



Educational institutions such as primary schools where installation work cannot be performed on weekdays.



Hotels where it is preferable to complete installation work during late evenings.



Rehabilitation facilities or hospitals where it is necessary to minimise the burden on users.

DEFINITION OF TERMS IN HITACHI CENTRALISED CONTROL SYSTEMS

1. CS-Net/Central Station
→ Hitachi original central controller
2. RC Group (Remote Controller System Group)
→ Stands for a number of indoor units (up to 16 units) connected using "same remote controller" wiring. In this group, connected indoor units are all controlled in the same way.
3. Group
→ Stands for the multiple "RC groups" that are registered in the central controller network setting.
4. Block
→ Stands for the multiple "groups" that are registered in the central controller network setting.

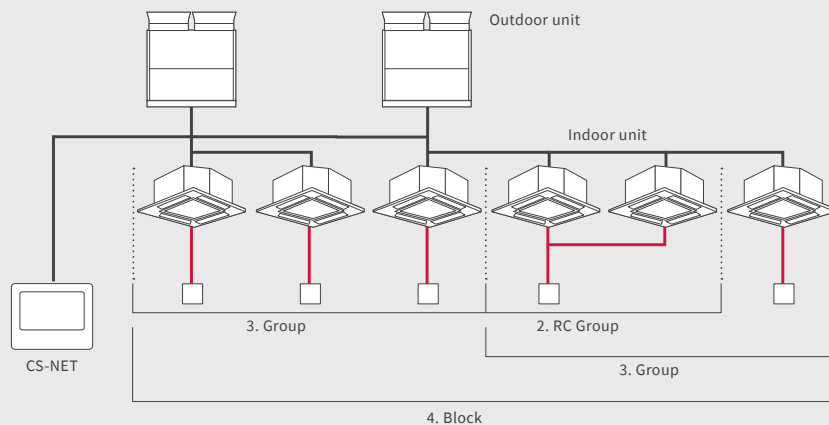

POINT

Case 1 –Heat pump

In case of Heat pump system, basic transmission wiring is between outdoor units

Basic Wiring

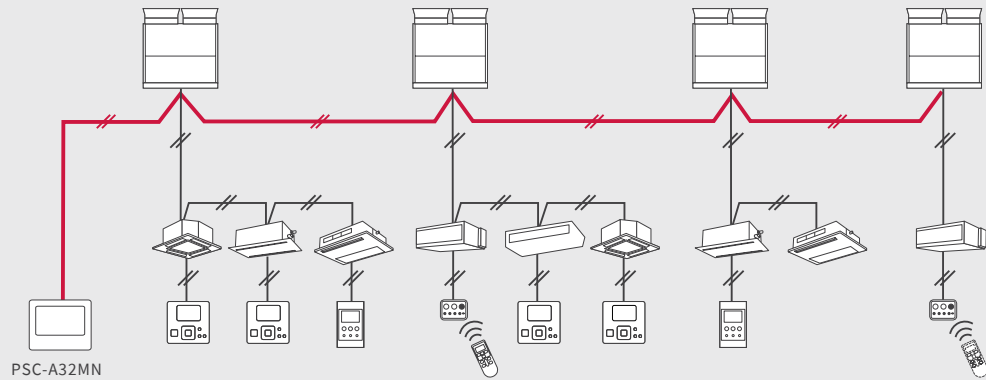

Case 2 –Heat recovery

In case of Heat recovery system, basic transmission wiring is between outdoor units. Since wiring between CH and indoors are not H-link wire, Please make sure to connect transmission wires between outdoors

Basic Wiring

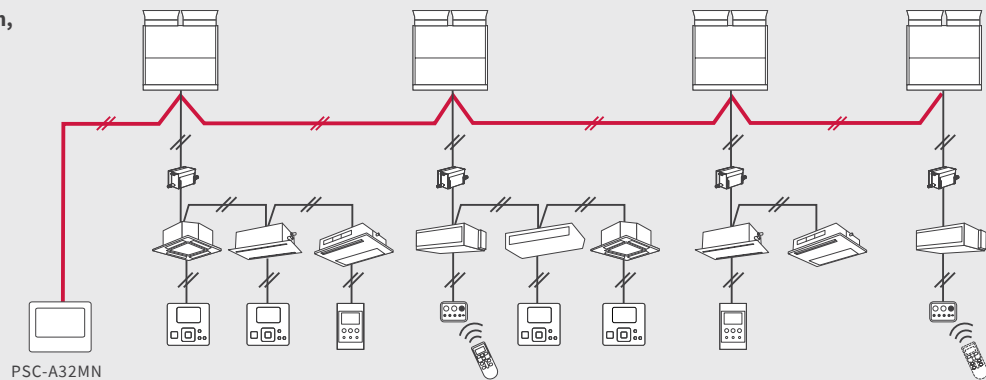

Case 3

(1) If indoor units are located in two places and any indoor units of each system are located close together

- Overall control is possible by connecting part of the indoor units of each system.
- Delivery distance can be greatly reduced.

Flexible Wiring Routes

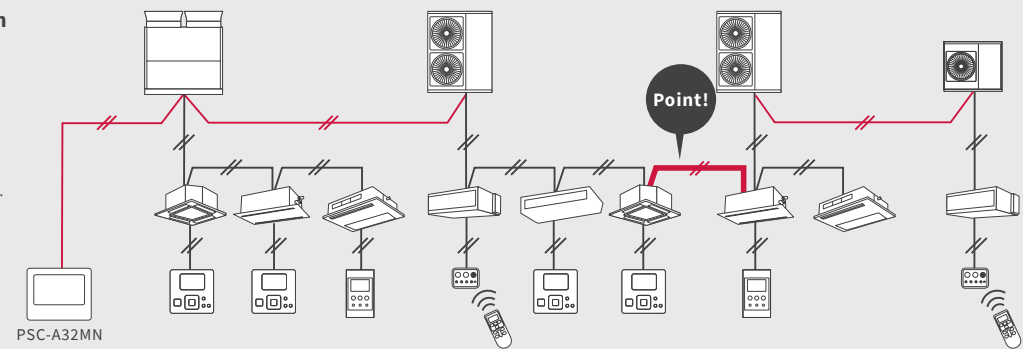

(2) If two systems are completely separated

- Overall control is possible by separately connecting the two systems to "concentrated control."
- It is possible to select a wiring route based on the wiring distance and the ease of installation.

Flexible Wiring Routes

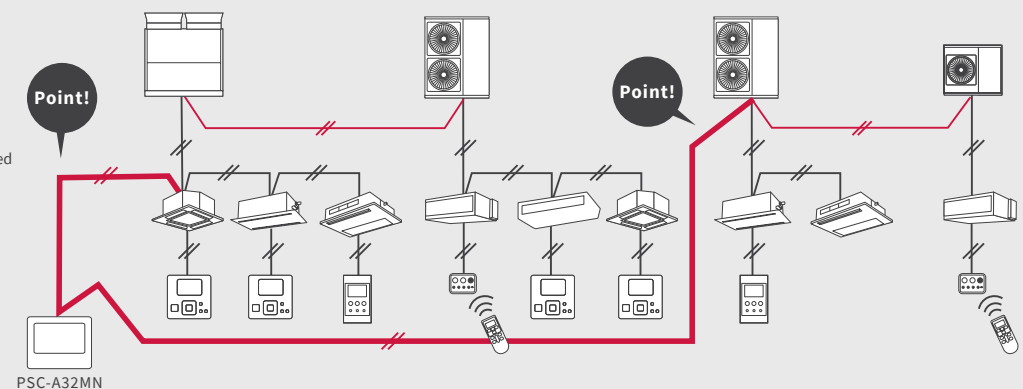

3P CONNECTOR CABLE **PCC-1A** (For Connection to Remote On/Off Device/Receipt of Output Signal)



*One set contains five 3P connector cables.

*PCC-1A can connect to external signal input-output terminal both in Outdoor Unit and Indoor Unit.

Operation «example»

Cooling Operation:

Compressor is ON by closing terminals 2 and 3 of CN3

Compressor is OFF by opening terminals 2 and 3 of CN3

Heating Operation:

Compressor is ON by closing terminals 1 and 2 of CN3

Compressor is OFF by opening terminals 1 and 2 of CN3

EXAMPLE OF SYSTEM CONFIGURATION

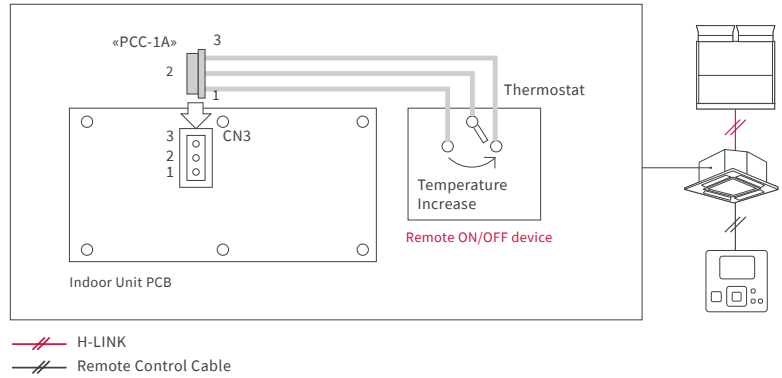

REMOTE SENSOR **THM-R2A** (To sense the indoor temperature)



EXAMPLE OF SYSTEM CONFIGURATION

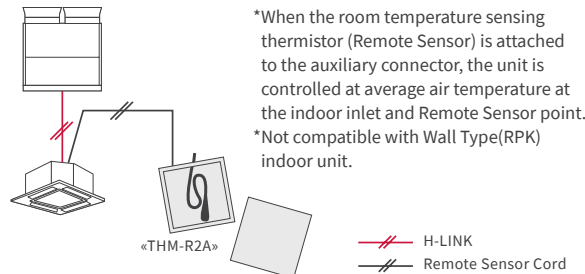

SPECIFICATIONS

Outer Dimensions (H×W×D)
(mm) 50.0×50.0×15.0

Length m 8.00

REMOTE CONTROL CABLE **PRC-5K, 10K, 15K** (For PC-ARF1 connection (to IDU))



EXAMPLE OF SYSTEM CONFIGURATION

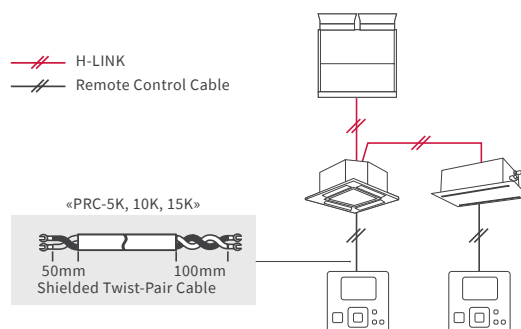

SPECIFICATIONS

	PRC-5K	PRC-10K	PRC-15K
Length m	5.00	10.00	15.00

*PC-ARF1 does not include a remote control cable.
Use this cable if you don't have one available in your field.

BMS ADAPTER for BACnet® HC-A64BNP1
Control up to 64 Indoor Units



SPECIFICATIONS

Outer Dimensions (H×W×D)
(mm) 68.0×240.0×154.0

FUNCTIONS

Corresponding BACnet® Standard	ANSI/ASHRAE Standard 135-2004 BACnet®
Control Item at Upper System	<ul style="list-style-type: none"> • Run Stop (Setting) • Operation Mode (Setting) • Fan Speed Level (Setting) • Indoor Temperature (Setting) • Prohibiting RC Operation (Setting) • Filter Sign Reset
Monitoring Item at Upper System	<ul style="list-style-type: none"> • Run Stop (State) • Operation Mode (State) • Fan Speed Level (State) • Indoor Temperature (State) • Prohibiting RC Operation (State) • Filter Sign • Indoor Air Intake Temperature • Alarm Signal • Alarm Code • Communication State

EXAMPLE OF SYSTEM CONFIGURATION

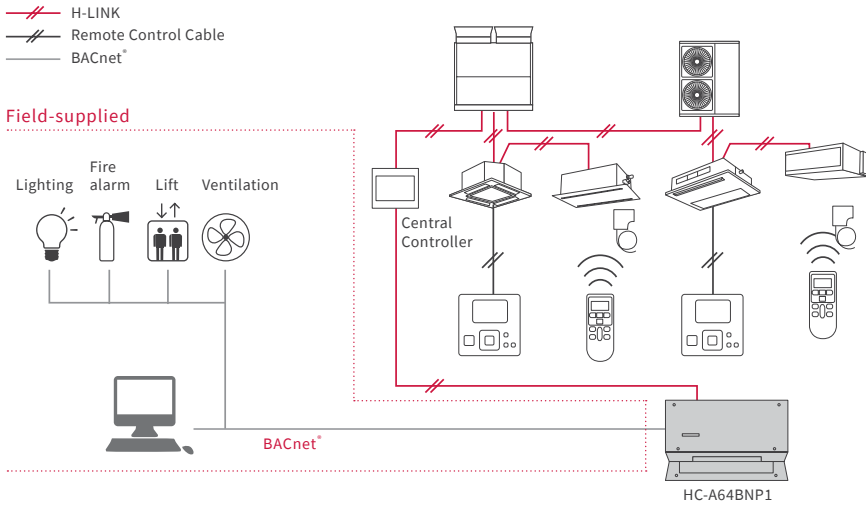

OUR HERITAGE

MAIN PRODUCTS

Air Compressor, Casting

Roller, Casting

PAC, Refrigerators, Compressor for REF, Casting

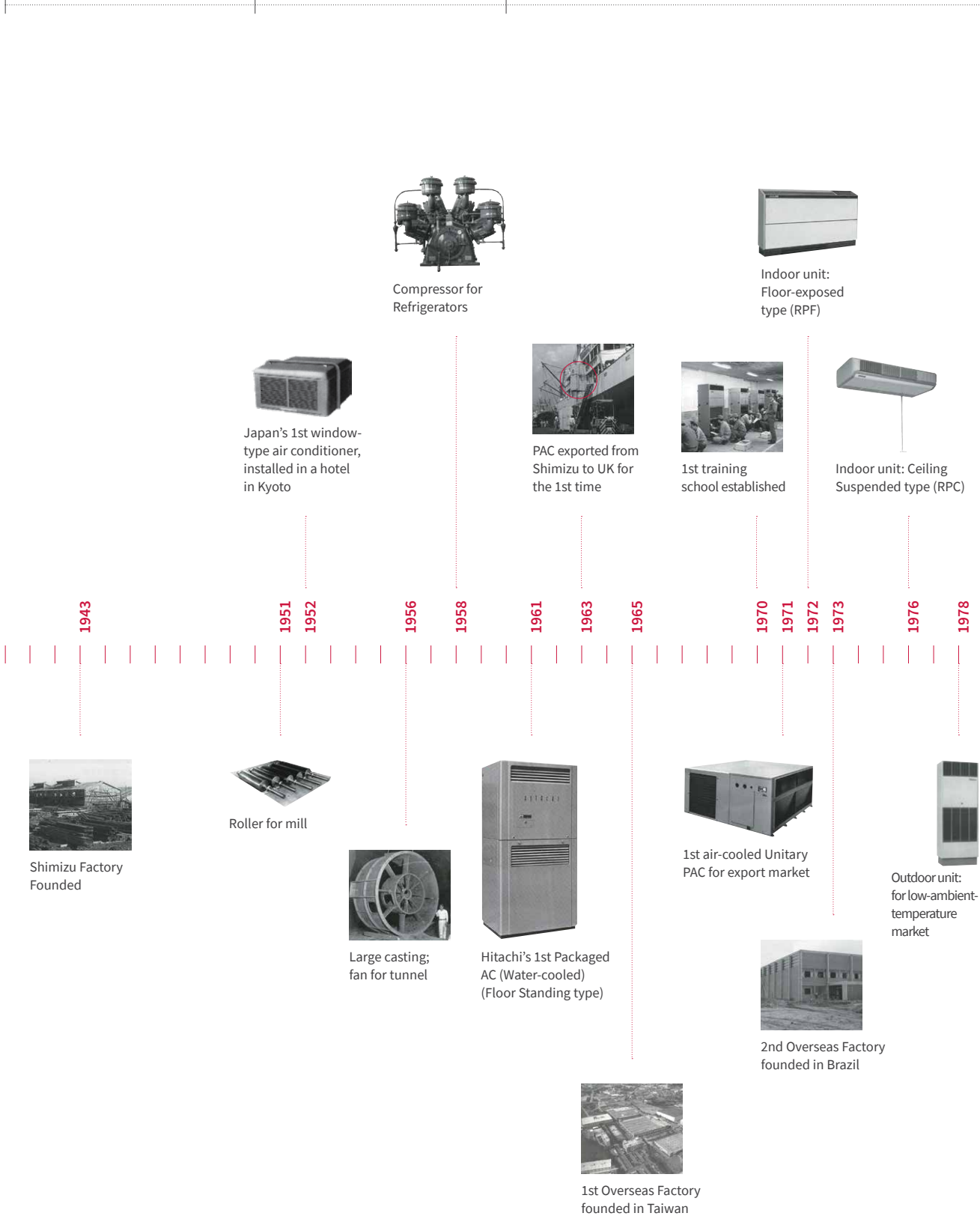

PAC, Refrigerators,
Compressor

VRF, PAC,
Compressors

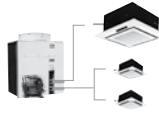

VRF 1ST GENERATION

- Hitachi's first VRF "High-Multi" series
Contains multiple reciprocating compressors
Individual indoor unit control available



5th overseas factory
in the Philippines



1st Scroll Compressor
Factory in China



6th overseas factory
in China



Indoor unit: Ceiling
Cassette type



Outdoor unit:
PAC controlled by
micro-computer
built-in

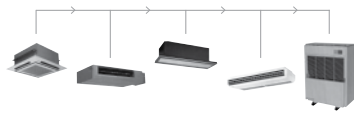

VRF 3RD GENERATION

- Up to 5 indoor units
World 1st IGBT
Inverter-driven VRF
Up to 115 Hz 1986



VRF 5TH GENERATION

- Up to 12 indoor units
(130% in capacity)
Newly R407C adopted VRF "SET FREE
FSG": heat-pump type "SET FREE FXG":
heat-recovery type



VRF 7TH GENERATION

54HP
- Heat-pump/Heat-recovery
compatible Modular System VRF
"SET FREE FSXN"

1979

1981

1982

1983

1984

1986

1988

1990

1991

1996

1999

2003

2005

2011

2012

2016



Indoor unit:
Wall Mounted
type (RPK)



VRF 2ND GENERATION

- Hitachi's 1st Inverter-
driven VRF With Scroll
Compressor built-in

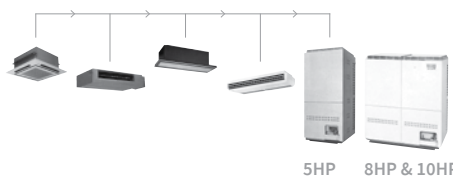

VRF 4TH GENERATION

10 HP
- Up to 8 indoor units (130% capacity)
World 1st IGBT built-in Inverter
VRF leading to top-in-class
quietest operation



5HP 8HP & 10HP



Centrifugal VRF
Point:"Outdoor unit"
that can be installed
inside the building



Scroll Compressor
Production for
AC unit



3rd overseas factory
in Malaysia



VRF 6TH GENERATION

32 HP
- Newly R410A adopted VRF
"SET FREE FSN": heat-pump type
"SET FREE FXN": heat-recovery type



VRF 8TH GENERATION

96HP
- Hitachi New Generation VRF
This New Generation VRF
is 8th Generation VRF
after 33 Years Experience in VRF





ENQUIRIES

nzsales@temperzone.com

NEW ZEALAND

Auckland: (09) 279 5250
Wellington: (04) 569 3262
Christchurch: (03) 379 3216

AUSTRALIA

Sydney: (02) 8822 5700
Melbourne: (03) 8769 7600
Brisbane: (07) 3308 8333
Adelaide: (08) 8115 2111

DISTRIBUTORS

Newcastle: (02) 4962 1155
Perth: (08) 6399 5900
Launceston: (03) 6331 4209



WARRANTY

3 year warranty on parts and labour when commissioned by Temperzone.
12 month warranty on parts only when not commissioned by Temperzone.

hitachiaircon.co.nz
temperzone.biz



ISO 9000 series
Shimizu Air Conditioning Headquarters, Professional-Use Air Conditioning
Business Division, Johnson Controls – Hitachi Air Conditioning
JQA-1084 obtained in November 1995



ISO 14000 series
Shimizu Business Office, Johnson Controls – Hitachi Air Conditioning
EC97J1107 obtained in October 1997

The specifications of this catalogue may change without prior notice to allow Hitachi Cooling & Heating to incorporate the latest innovations for its customers. The information contained in this catalogue is merely informative. Hitachi Cooling & Heating declines any responsibility in the broadest sense, for damage, direct or indirect, arising from the use and / or interpretation of the recommendations in this catalogue.